

Results of Geomagnetic Observations Belsk, Hel, Hornsund, 2008

Jan REDA, Mariusz NESKA and Stanisław WÓJCIK

Institute of Geophysics, Polish Academy of Sciences
ul. Księcia Janusza 64, 01-452 Warszawa, Poland

1. INTRODUCTION

This publication contains basic information on geomagnetic observations carried out in 2008 in three Polish geophysical observatories: Belsk (BEL), Hel (HLP), and Hornsund (HRN). All these observatories belong to the Institute of Geophysics, Polish Academy of Sciences. Observatories Belsk and Hel are located on the territory of Poland, while Hornsund is in Spitsbergen archipelago, governed by Norway.

In 2008, like in the previous years, the Belsk, Hel and Hornsund observatories have kept a close collaboration with the world network of geomagnetic observatories INTERMAGNET. The Belsk Observatory joined INTERMAGNET in 1992, Hel in 1999, and Hornsund in 2002.

2. DESCRIPTION OF OBSERVATORIES

The location of observatories is shown in Fig. 1 and Table 1. The geomagnetic coordinates in Table 1 were calculated in relation to the geomagnetic pole located at 83.2°N, 118.3°W on the basis of model IGRF-10 from epoch 2005.

The methodology of geomagnetic observations in all the three observatories was very similar, based on the "Guide for Magnetic Measurements and Observatory Practice" (Jankowski and Sucksdorff 1996). The instruments were similar too. Absolute measurements were made with the use of DI-flux magnetometers and proton magnetometers. The magnetic field variations were measured with the use of PSM magnetometers equipped in Bobrov's quartz variometers. The spare sets are equipped in PSM magnetometers or LEMI flux-gate magnetometers.



Fig. 1. Location of the Belsk, Hel and Hornsund observatories.

Table 1

Coordinates of the Polish observatories

Observatory	Geographic coordinates		Geomagnetic coordinates		Elevation [m]
	Latitude	Longitude	Latitude	Longitude	
Belsk (BEL)	51°50.2' N	20°47.5' E	50.2°N	105.2°E	180
Hel (HLP)	54°36.5' N	18°49.0' E	53.2°N	104.6°E	1
Hornsund (HRN)	77°0.0' N	15°33.0' E	73.9°N	126.0°E	15

Continuous recording has been made by means of microprocessor-based digital loggers DR-02 or DR-03. Owing to the recording system we use and the fact that we strictly obey the procedures relating to the so-called magnetic service, the gaps in one-minute data from Belsk and Hel are practically absent. Short gaps have only occurred in records of the Hornsund station, because the conditions prevailing there are much harder than in Poland.

It is worth mentioning that in 2008 the Belsk and Hornsund Observatories have been continuing the permanent observation of the Schumann resonance. Two horizontal magnetic components and the vertical component of the electric field have been recorded at a frequency of 100 Hz. This recording was initiated in both observatories in 2004 (Neska and Satori 2006).

2.1 Central Geophysical Observatory at Belsk, Central Poland

The Observatory at Belsk began continuous observations of the Earth magnetic field in 1965 (Jankowski and Marianiuk 2007). It continued the activity of the first Polish magnetic Observatory at Świder near Warsaw, working incessantly through the years 1920-1975. The magnetic observations were transferred from Świder to Belsk because of a strong increase of artificial noise from the Warsaw agglomeration, in particular due to the electric railroad passing nearby the Świder Observatory.

The Belsk Observatory is located at a distance of about 50 km south of Warsaw and about 2 km northwest of the village Belsk Duży. The premises of the Observatory, about 10 ha in area, is at the edge of the forest reserve Modrzewina, far away of people's settlements and automobile traffic. The location of the observatory in relation to the nearby towns and villages is shown in Fig. 2. The Observatory is surrounded by typically agricultural regions (with fertile soil, mostly apple orchards), so the direct neighborhood is deprived of sources of major artificial geomagnetic field disturbances. It is only the electric railroad (DC powered) situated some 14 km away of the Observatory to the north that produces some small artificial magnetic disturbances, whose average level usually does not exceed 1 nT.

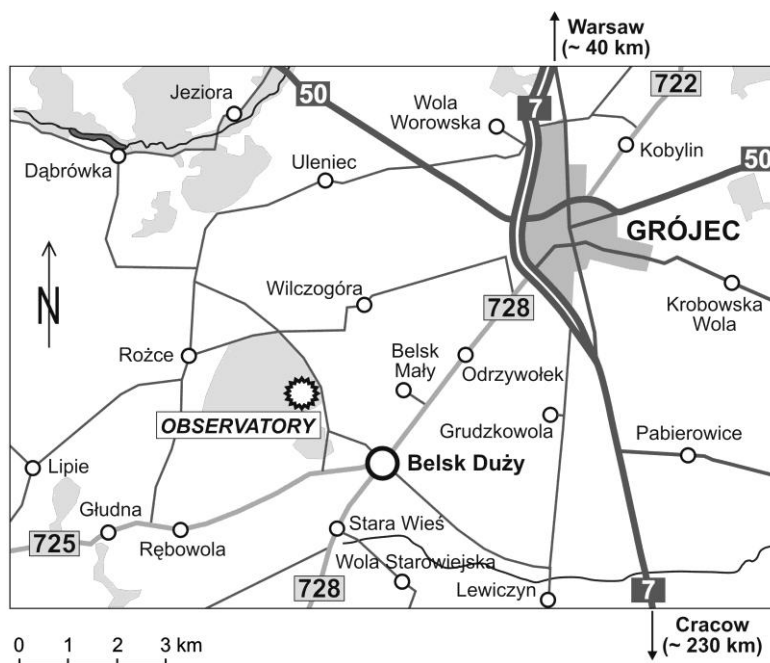

Fig. 2. Location of the Belsk Geophysical Observatory.

More information about the region in which the Observatory is located can be found, in English, Polish and German, on the internet pages of Grójec district (<http://www.grojec.pl>) to which the village Belsk Duży belongs. Relevant information can also be found at page of the Belsk Observatory (http://www.igf.edu.pl/pl/obserwatoria/cog_belsk).

2.2 Geophysical Observatory at Hel, Northern Poland

The Observatory at Hel began continuous observations of the earth magnetic field in 1932 (Jankowski and Marianiuk 2007). The observations were stopped in 1939, after the outbreak of World War II. During the war, the Observatory as well as its equipment and data were completely destroyed. After reconstruction, continuous observations at Hel were resumed in 1957.

The Hel Observatory is located in a small resort town at the end of Hel Peninsula by the Bay of Gdańsk (see Fig. 3). It is the area of Seaside Landscape Park (Nadmorski Park Krajobrazowy), weakly industrialized and urbanized. The region, surrounded by water from three sides, lacks any major artificial noise and is a good place for continuous magnetic observations.

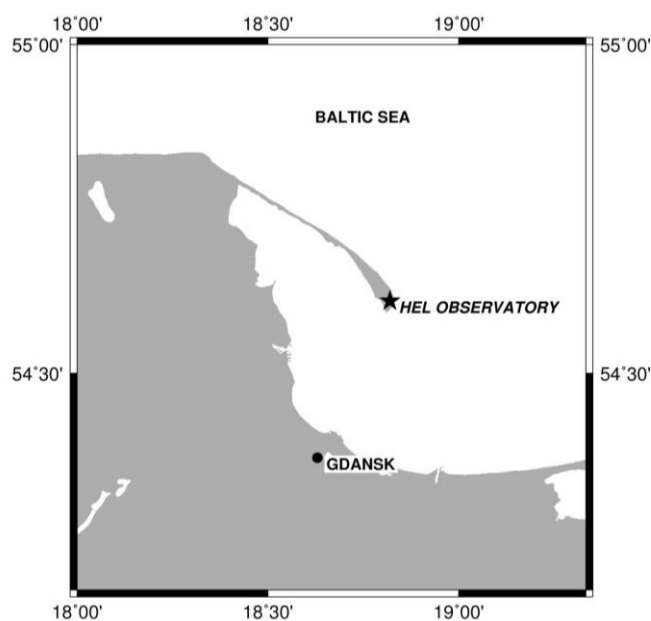

Fig. 3. Location of the Geophysical Observatory at Hel.

The observatory premises, about 4.5 ha in area, is surrounded by mixed forest (mainly pine and birch trees). Pavilions with measurement and recording instruments are located at small clearings.

More information about the town of Hel where the Observatory is located can be found at the address: <http://www.hel-miasto.pl/>.

2.3 Hornsund, Spitsbergen

The Polish Polar Station Hornsund (PSP Hornsund) is situated on the White Bear Bay (Isbjørnhamna) in Hornsund Fiord, Spitsbergen Island, Svalbard archipelago. (See Fig. 4). More information on the Svalbard Archipelago can be found at the address: <http://svalbard.com>.

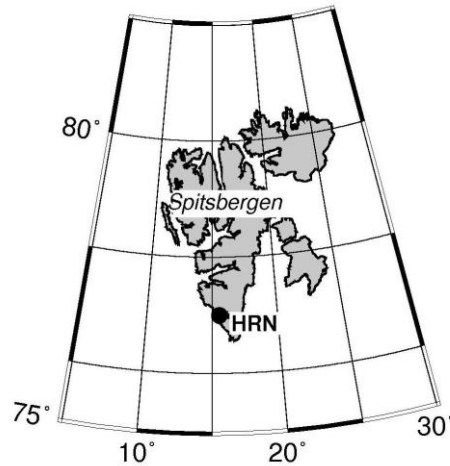

Fig. 4. Location of Polish Polar Station Hornsund.

The Hornsund station is the northernmost Polish scientific facility carrying out year-round activity. The Hornsund region is situated in a zone of strong magnetic field activity, much stronger than on the magnetic pole. Therefore, it is a very interesting place for magnetic observations.

Polish geomagnetic observations in the Arctic were initiated during the II Polar Year; a magnetic station was then established by S. Siedlecki and C. Centkiewicz on the Bear Island. In the years 1932/33, they had carried out continuous recording of magnetic field and performed absolute measurements. In the years 1957/58, in the framework of the International Geophysical Year, measurements of magnetic declination and inclination were made by J. Kowalczyk and K. Karaczun in five sites in the Hornsund Fiord region.

Since the beginning of October 1978, continuous magnetic field recording has been put into operation, and systematic absolute measurements have been implemented (Jankowski and Marianiuk 2007). Since then, PSP Hornsund has begun to fulfill all the requirements for geomagnetic observatory.

Since 1993, PSP Hornsund has been participating in the IMAGE (International Monitor for Auroral Geomagnetic Effects) project. In the framework of this project, Hornsund data are being sent to a server in Finland, once a month on the average. Since 2002, PSP Hornsund is included into the global near-real-time magnetic observatory network INTERMAGNET, sending the results, via Internet, to the GIN (Geomagnetic Information Nodes) centers in Edinburgh and Paris.

3. INSTRUMENTATION

3.1 Introduction

Simplified block diagrams of geomagnetic observations in Belsk, Hel, and Hornsund Observatories are shown in Figs. 5, 6, and 7.

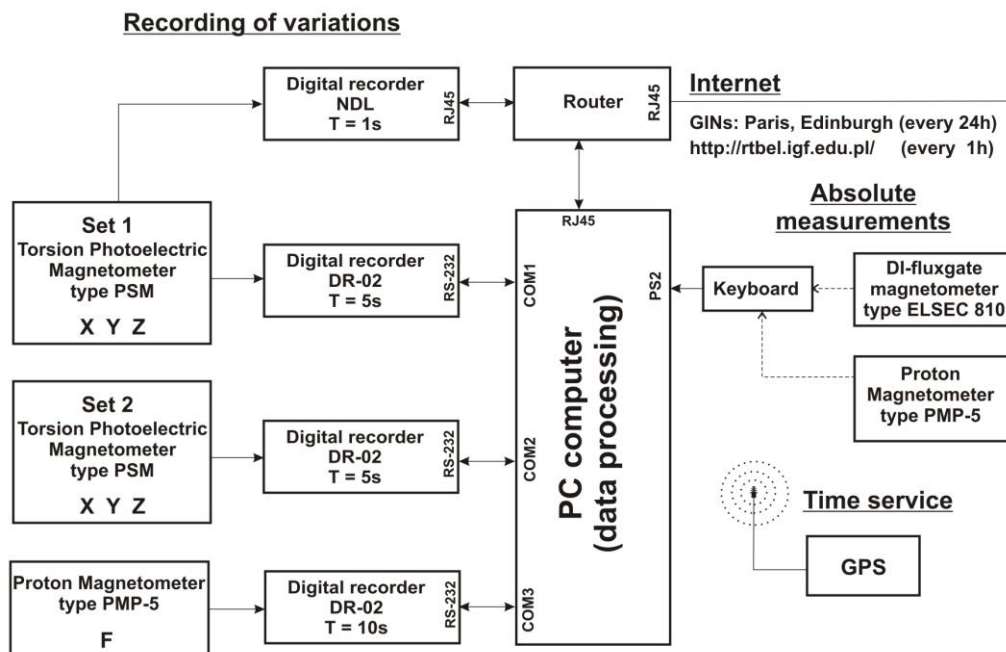

Fig. 5. Block diagram of magnetic observations system at Belsk

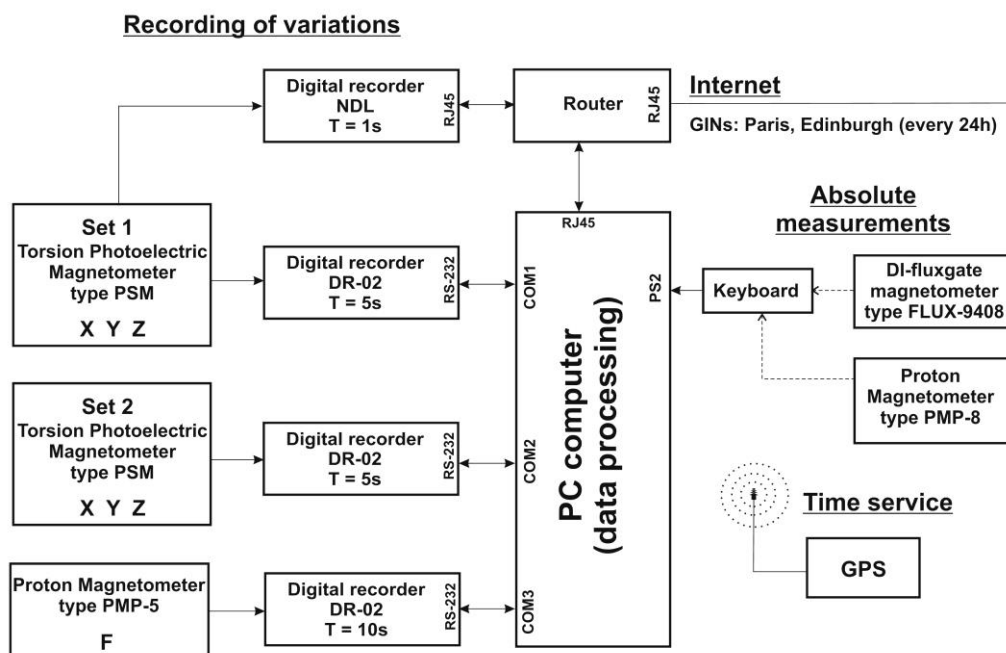

Fig. 6. Block diagram of magnetic observations system at Hel.

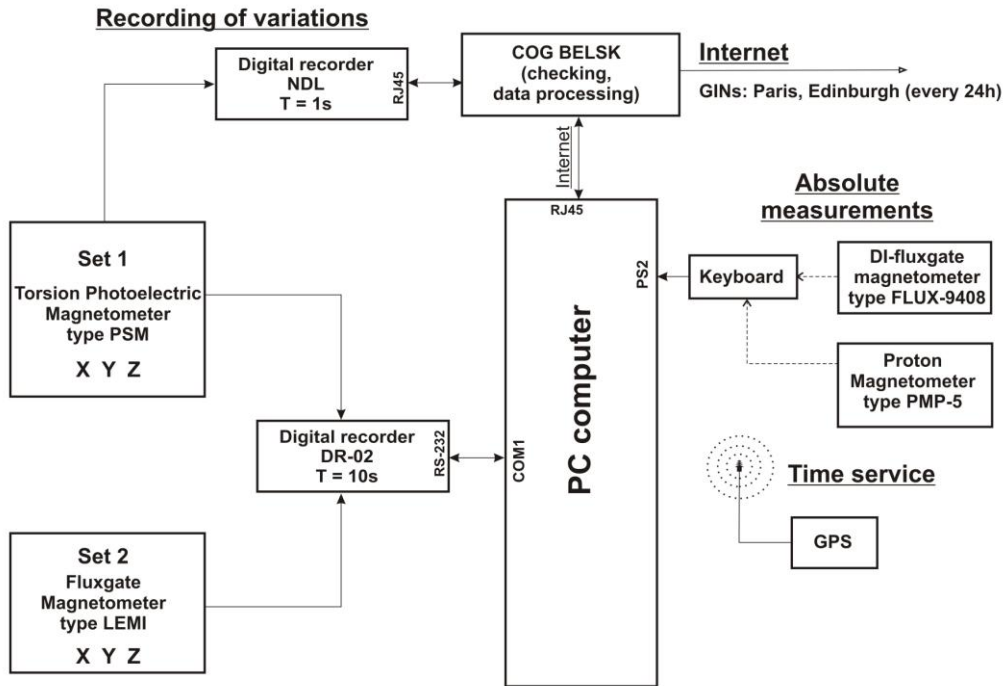

Fig. 7. Block diagram of the magnetic observations system at the Polish Polar Station Hornsund.

3.2 Absolute measurements

In all the three Polish observatories, the absolute measurements used for determination of bases of the recordings are performed by means of DI-flux and proton magnetometers. Di-flux magnetometers measure the absolute values of the angles of declination D and inclination I , while the proton magnetometers measure the absolute values of the total magnetic field vector F . From the measured values of F , D , and I , we can calculate all the remaining magnetic field components, H , X , Y , and Z .

The instruments for absolute measurements are listed in Table 2, and the basic parameters of the instruments in Table 3.

The results of absolute measurements are determined by means of a special computer package DIFLUX, which calculates the base values on the basis of data from the measurement protocol (Tomczyk 2008).

The bases B_A of digital recording of elements X , Y and Z were calculated from the formula:

$$B_A = A - \epsilon_A \times (a - 32768),$$

where A is the result of absolute measurement [nT], ϵ_A is the scale value of the recording [nT/bit], a is the recorded instantaneous value [bits].

For the digital records with a resolution of 16 bits, the values of $2^{15} = 32768$ bits, corresponding to zero voltages on inputs of these loggers, were adopted as the base levels.

Table 2

Instruments for absolute measurements

	Belsk	Hel	Hornsund
DI-fluxgate (fluxgate, theodolite)	ELSEC 810, THEO-10B sn: 002208	FLUX-9408 THEO-10B sn: 160334	FLUX-9408 THEO-10B sn: 160326
Proton magnetometer	PMP-5 sn: 128 PMP-8 sn: 13/1998	PMP-8 sn: 21/2006	PMP-5 sn: 115
Frequency of measurements	6 per week	2 per week	2 per week

Table 3

Basic parameters of the instruments for absolute measurements

Fluxgate declinometer/inclinometer ELSEC 810 / THEO-10B	
Producer	ELSEC Oxford, UK
Mean square error of a horizontal direction	$\sigma_D \approx \pm 5''$
Mean square error of a zenith direction	$\sigma_I \approx \pm 5''$
Fluxgate declinometer/inclinometer FLUX-9408 / THEO-10B	
Producer (FLUX-9408).....	Institute of Geophysics Pol. Acad. Sc.
Mean square error of a horizontal direction	$\sigma_D \approx \pm 5''$
Mean square error of a zenith direction	$\sigma_I \approx \pm 5''$
Proton magnetometer model PMP-8	
Producer	Institute of Geophysics Pol. Acad. Sc.
Resolution	0.01 nT
Absolute accuracy	0.2 nT
Proton magnetometer model PMP-5	
Producer	Institute of Geophysics Pol. Acad. Sc.
Resolution	0.1 nT
Absolute accuracy	0.2 nT

Results of base determinations and the smoothed values adopted for further computations are depicted in Figs. 8, 9, 17, 18 and 26 in the chapters describing individual observatories.

The mean random errors of a single base measurement, m_B , and the number of measurements n taken in 2008 are listed in Table 4.

Thermal coefficients of magnetic sensors are not taken into account in calculations, with a view to the following facts:

- tests made every few years indicated that the coefficients are very small, less than $0.2 \text{ nT}/^\circ\text{C}$,

- the magnetic sensors are located in thermostat-controlled wooden boxes where the daily temperature variations are of the order of 0.1-0.2°C.

Table 4
Mean errors of measurements of B_X , B_Y and B_Z in 2008

Observatory	Element	Set I		Set II	
		Number of measurements [n]	Mean error [m _B] [nT]	Number of measurements [n]	Mean error [m _B] [nT]
Belsk	B_X	293	0.4	291	0.5
	B_Y	293	0.5	291	0.5
	B_Z	293	0.2	291	0.2
Hel	B_X	101	0.5	100	0.6
	B_Y	101	0.5	100	0.5
	B_Z	101	0.3	100	0.4
Hornsund	B_X	104	1.1	–	–
	B_Y	104	0.9	–	–
	B_Z	107	0.5	–	–

3.3 Recording of geomagnetic field variations

As we already mentioned, the continuous digital recordings of geomagnetic field variations in all the Polish observatories are performed by means of magnetometers PSM and digital loggers DR-02 (or DR-03). In spare sets, we use magnetometers PSM or LEMI. Both the main and spare sets record the components in the rectangular coordinate system X, Y, Z. At Belsk and Hel, continuous recording of the total magnetic field modulus F is performed as well. The basic parameters of the recording systems are listed in Table 5.

Magnetometers PSM

Magnetometers PSM were designed at the Institute of Geophysics PAS with the use of torsion quartz variometers of V.N. Bobrov system (Marianiuk 1977, Jankowski *et al.* 1984). In these magnetometers, the magnet's deflections in response to the magnetic field changes are transformed by means of photoelectric converters into the electric current changes. Owing to a strong negative feedback, the voltage changes on the output of the converter are in linear proportion to the magnetic field changes. The magnetometers PSM are characterized by good stability, of about 3-5 nT/year, and small noise, below 10 pT.

Table 5

Basic instruments for the magnetic field variations recording

		Belsk	Hel	Hornsund
SET 1	Name of magnetometer Kind of sensor	PSM Bobrov	PSM Bobrov	PSM Bobrov
	Type	PSM-8511-01P	PSM 8511-09P	PSM-8911-05P
	Sensor's orientation	XYZ	XYZ	XYZ
	Range	+/- 850 nT	+/- 850 nT	+/- 5000 nT
	Magnetometer's producer	Institute of Geophysics PAS	Institute of Geophysics PAS	Institute of Geophysics PAS
	Digital recorder Producer	DR-02, DR-03 EL-LAB	DR-03 EL-LAB	DR-02 EL-LAB
	Sampling interval	5 s and 1 s	5 s	10 s
SET 2	Name of magnetometer Kind of sensor	PSM Bobrov	PSM Bobrov	LEMI fluxgate
	Type	PSM-8511-01P	PSM 8511-03P	LEMI-003/95
	Sensor's orientation	XYZ	XYZ	XYZ
	Range	+/- 820 nT	+/- 820 nT	+/- 10.000 nT
	Magnetometer's producer	Institute of Geophysics PAS	Institute of Geophysics PAS	Institute of Geophysics PAS
	Digital recorder Producer	DR-02, DR-03 EL-LAB	DR-02 EL-LAB	DR-02 EL-LAB
	Sampling interval	5 s and 1 s	5 s	10 s
Total field	Name of magnetometer	PMP-5	PMP-5	–
	Producer	Institute of Geophysics PAS	Institute of Geophysics PAS	–
	Sampling interval	10 s	10 s	–

Magnetometers LEMI

Magnetometers LEMI were designed at the Lviv Centre of the Institute of Space Research (Ukraine). They employ flux-gate sensors. These magnetometers have been successfully used as auxiliary sets. Their stability is not much less than that of PSM's, and they are also characterized by good orthogonality of sensors and relatively small self noise.

Proton magnetometers PMP-5 and PMP-8

Magnetometers PMP-5 and PMP-8 were designed at the Institute of Geophysics PAS. These are classical proton magnetometers, in which the precession signal is forced in a cycle of proton polarization by means of direct current. The resolution of magnetometers PMP-5 is 0.1nT, that of PMP-8 being 0.01nT. The stability of both magnetometers is better than 0.3 nT/year. More information about PMP-8 magnetometer can be found on the page:

http://www.igf.edu.pl/pl/zaklady_naukowe/konstrukcji_aparatury/aparatura

Digital loggers DR-02 and DR-03

The digital loggers were designed in the early 1990s by the enterprise EL-LAB (Poland) especially for recording the long-term slow-changing variations. These are independent instruments and their cooperation with the computer resolves itself to the read-out of data via the RS-232 interface. Model DR-03 is equipped in clock synchronized by a GPS.

3.4 Calibration of magnetic sensors

The verification of scale values of recording systems in all the three observatories was made by the classical electromagnetic method: electric currents were passed through calibration coils woven over variometers. The currents induce the magnetic field of precisely known intensity. The measurements are made at least few times a year.

Table 6

Scale values adopted for computations in 2008

Observatory	Set	Period	Scale values		
			X [nT/bit]	Y [nT/bit]	Z [nT/bit]
Belsk	Set I	Jan 01-Dec 31	0.0250	0.0249	0.0249
	Set II	Jan 01-Dec 31	0.0249	0.0249	0.0249
Hel	Set I	Jan 01-Feb 27	0.0249	0.0249	0.0249
		Feb 28-Oct 23	0.0254	0.0251	0.0244
		Oct 24-Dec 31	0.0247	0.0247	0.0245
	Set II	Jan 01-Feb 27	0.0250	0.0250	0.0251
		Feb 28-Dec 31	0.0249	0.0250	0.0250
Hornsund	Set I	Jan 01-Dec 31	0.149	0.151	0.149
	Set II	Jan 01-Dec 31	0.307	0.308	0.307

The scale values of magnetometers PSM and LEMI, parameters of calibration coils of PSMs, and mutual orthogonality of sensors in PSMs and LEMIs is checked every few years in large calibration coils installed at the Belsk Observatory.

3.5 Data treatment

In processing the results of digital recordings we used the software packet developed for the needs of an observatory operating in the INTERMAGNET network. This software makes it possible to perform, among other things, the following operations:

- conversion of magnetic data into the INTERMAGNET text format IMFV1.22 and creation in this format of daily files containing one-minute means of X, Y, Z and F (authors: J. Reda and A. Pałka),
- automatic transmission of data, via the Internet, to the Institute of Geophysics PAS in Warsaw and data centers in Paris and Edinburgh (author: M. Neska),
- archivation of data and plotting of magnetograms (author: J. Reda),
- calculation of results of absolute measurements (author: S. Tomczyk),
- automatic calculation of geomagnetic indices K (Nowożyński *et al.* 1991). The indices are calculated with the use of ASm (Adaptive Smoothed) method, developed at the Institute of Geophysics PAS, and recommended by IAGA in 1991. The currently used program calculates the indices from one-minute means in the INTERMAGNET CD-ROM Data Format or in the IMFV1.22 format. The program for calculation of indices may be taken from the INTERMAGNET page: http://www.intermagnet.org/Software_e.html
- test printouts to check various parameters of recording adopted for calculation and a possibility of looking over current and past data curves or tables.

The diagrams illustrating the annual variations of X, Y, and Z, monthly variations of X, Y, Z and F, bases of recording sets as well as plots of K indices for 2008 were prepared with the use of program `imagplot.exe` provided to us by INTERMAGNET. The diagrams prepared by means of `imagplot.exe` and other diagrams related to 2008 data are shown in Figs. 8–32.

In the present yearbook, we include for the first time the E indices calculated for Belsk observatory. The E indices, unlike the K indices, are calculated on the basis of energy analysis. They have been described in detail by Reda and Jankowski (2004).

3.6 Data availability

The newest data from Belsk, Hel and Hornsund observatories can be viewed in graphic form through the WEB application

<http://rtbel.igf.edu.pl>

described by Nowożyński and Reda (2007).

On this page, the Belsk and Hel data appear with one-hour delay, while the delay for Hornsund is few hours. The page makes it possible to view the archival data from any observatory belonging to the INTERMAGNET network (in the form of curves on the screen). It offers also a possibility of calculating the K indices according to the ASm method (Nowożyński *et al.* 1991) and E indices (Reda and Jankowski 2004).

The current data (of status REPORTED) from all the three observatories can be found in INTERMAGNET at the Internet address:

http://www.intermagnet.org/apps/dl_data_prel_e.php

Data from Belsk, Hel and Hornsund are also available from the WDCs. Addresses of some WDC pages with magnetic data are the following:

WDC for Geomagnetism, Edinburgh <http://www.wdc.bgs.ac.uk/catalog/master.html>

WDC for Geomagnetism, Kyoto <http://swdc234.kugi.kyoto-u.ac.jp/>

All the three observatories have in their archives the original data, whose sampling periods are listed in Table 5. For those interested, these data can be made available on request.

4. CONTACT PERSON, POSTAL ADDRESS, CONTACT DETAILS

4.1 Belsk Observatory

Jan Reda, Mariusz Neska
 Central Geophysical Observatory
 05-622 Belsk
 Poland
 Tel.: +48 486610830 Fax: +48 486610840
 E-mail: jreda@igf.edu.pl (J. Reda), nemar@igf.edu.pl (M. Neska)
http://www.igf.edu.pl/pl/obserwatoria/cog_belsk

4.2 Hel Observatory

Stanisław Wójcik
 Geophysical Observatory
 ul. Sosnowa 1
 84-150 Hel
 Poland
 Tel./Fax +48 58 6750480
 E-mail: hel@igf.edu.pl
<http://www.igf.edu.pl>

4.3 Hornsund

Mariusz Neska
 Central Geophysical Observatory
 05-622 Belsk
 Poland
 Tel.: +48 486610833 Fax: +48 486610840
 E-mail: nemar@igf.edu.pl
<http://hornsund.igf.edu.pl>, <http://www.igf.edu.pl>

5. PERSONNEL TAKING PART IN THE WORK OF BELSK, HEL AND HORNSUND OBSERVATORIES IN 2008

5.1 Belsk

- Jan Reda (head of Geomagnetic Laboratory at Belsk to June 2008)
- Mariusz Neska (head of Geomagnetic Laboratory at Belsk since July 2008)
- Janusz Marianiuk (consulting)
- Halina Suska (data processing, observer)
- Krzysztof Kucharski (observer)
- Paweł Czubak (data processing, since October 2008)
- Józef Skowroński (observer)

5.2 Hel

- Stanisław Wójcik (head of Geophysical Observatory)
- Anna Wójcik (observer)
- Mariusz Neska (data processing)
- Jan Reda (data processing)

5.3 Hornsund

- Mariusz Neska (head of geomagnetic observations)
- Paweł Czubak (observer in 1-st half-year)
- Piotr Łepkowski (observer in 2-nd half-year)
- Jan Reda (data processing)

References

- Jankowski, J., and C. Sucksdorff (1996), *Guide for Magnetic Measurements and Observatory Practice*, IAGA, Warsaw, 235 pp.
- Jankowski, J., J. Marianiuk, A. Ruta, C. Sucksdorff, and M. Kivinen (1984), Long-term stability of a torque-balance variometer with photoelectric converters in observatory practice, *Geophys. Surv.* **6**, 3/4, 367-380.
- Jankowski, J., and J. Marianiuk (2007), Past and present of Polish geomagnetic observatories, *Publs. Inst. Geophys. Pol. Acad. Sc.* **C-99 (398)**, 20-31.
- Marianiuk, J. (1977), Photoelectric converter for recording the geomagnetic field elements: construction and principle of operation, *Publs. Inst. Geophys. Pol. Acad. Sc.* **C-4 (114)**, 57-73.
- Neska, M., and G. Satori (2006), Schumann resonance observation at Polish Polar Station at Spitsbergen and in Central Geophysical Observatory in Belsk, Poland, *Przeł. Geofiz.* **3-4**, 189-198, (in Polish).
- Nowożyński, K., T. Ernst, and J. Jankowski (1991), Adaptive smoothing method for computer derivation of K-indices, *Geophys. J. Int.* **104**, 85-93.

- Nowożyński, K., and J. Reda (2007), Comparison of observatory data in quasi-real time, *Publs. Inst. Geophys. Pol. Acad. Sc.* **C-99 (398)**, 123-127.
- Reda, J., and M. Neska (2007), Measurement Session during the XII IAGA Workshop at Belsk, *Publs. Inst. Geophys. Pol. Acad. Sc.* **C-99 (398)**, 7-19.
- Reda, J., and J. Jankowski (2004), Three hour activity index based on power spectra estimation, *Geophys. J. Int.* **157**, 141-146.
- Reda, J. (editor) (2007), XII IAGA Workshop on Geomagnetic Observatory Instruments, Data Acquisition and Processing, Belsk, 19-24 June 2006, Monographic Volume, *Publs. Inst. Geophys. Pol. Acad. Sc.* **C-99 (398)**, 397 pp.
- Tomczyk, S. (2008), DIFLUX software package for calculation of absolute measurement results, *Publs. Inst. Geophys. Pol. Acad. Sc.* **C-100 (402)**, 61-67.
- Technical data of PMP-8:

http://www.igf.edu.pl/pl/zaklady_naukowe/konstrukcji_aparatury/aparatura

Received March 23, 2009

Accepted April 27, 2009

Tables and plots for Belsk Observatory

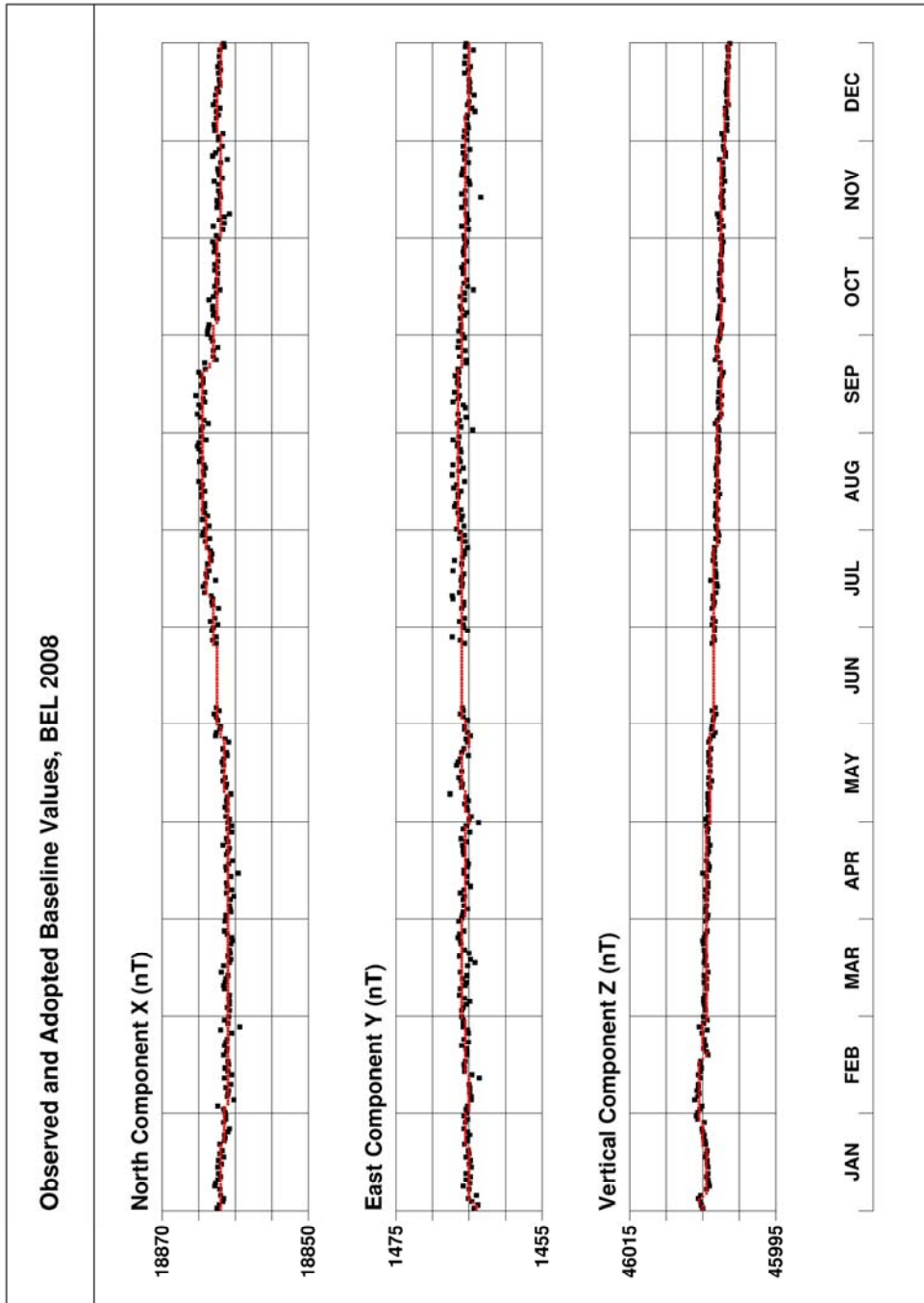

Fig. 8. Base values of set 1, Belsk 2008.

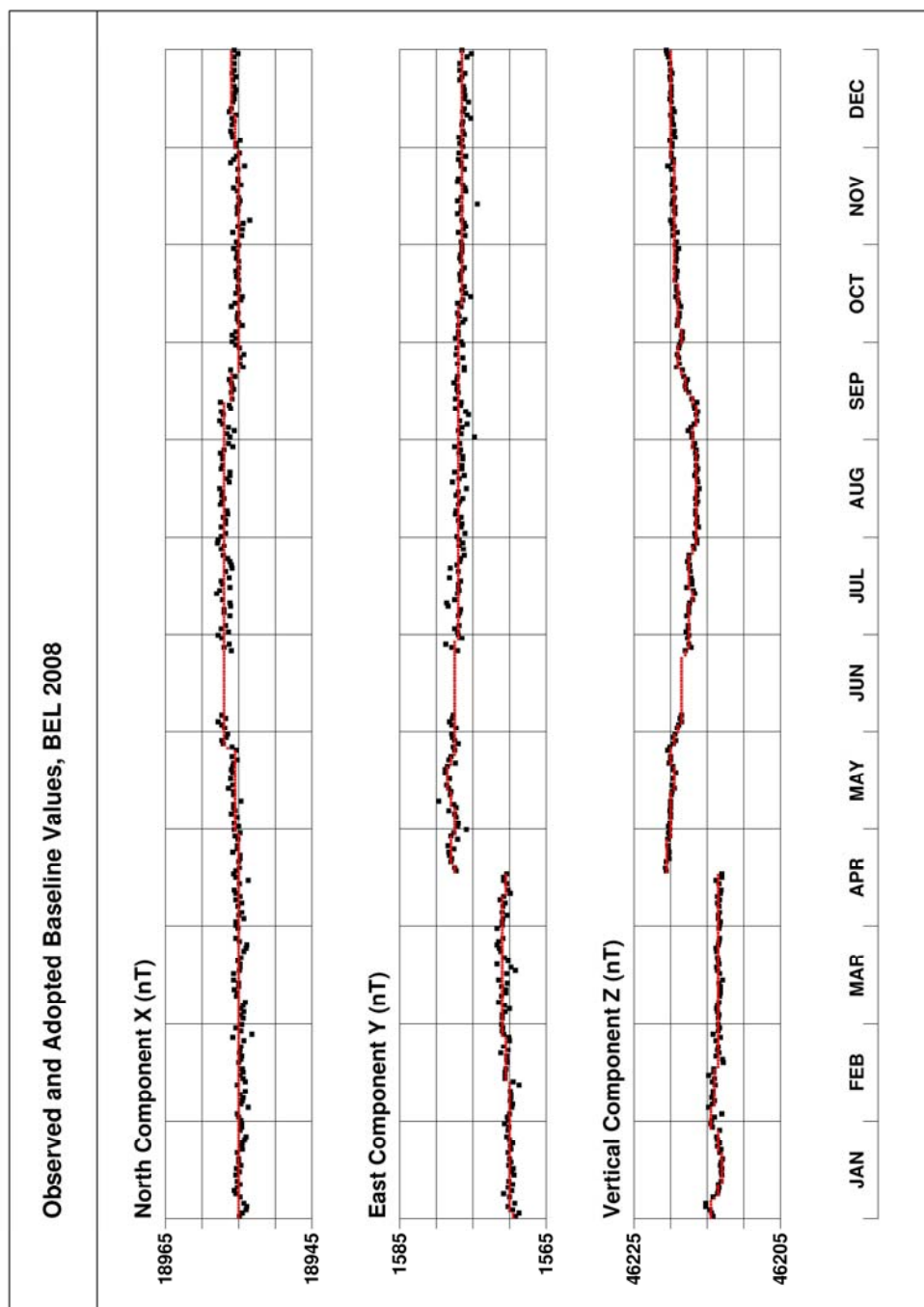

Fig. 9. Base values of set 2, Belsk 2008.

Annual mean values of magnetic elements in Belsk Observatory

No	Year	D [° ‘]	H [nT]	Z [nT]	X [nT]	Y [nT]	I [° ‘]	F [nT]
1	1966	2 04.2	18901.2	45023.3	18888.9	682.8	67 13.6’	48829.8
2	1967	2 05.6	18906.2	45047.7	18893.6	690.7	67 14.0	48854.3
3	1968	2 06.2	18917.8	45071.3	18905.5	694.6	67 13.8	48880.5
4	1969	2 06.3	18935.7	45093.5	18922.9	695.6	67 13.3	48907.9
5	1970	2 06.6	18953.0	45123.1	18940.2	697.7	67 13.0	48941.9
6	1971	2 06.6	18975.5	45146.4	18962.6	698.8	67 12.2	48972.1
7	1972	2 08.0	18991.6	45176.3	18978.4	706.7	67 11.9	49005.9
8	1973	2 10.2	19004.6	45210.8	18991.0	719.4	67 12.0	49042.8
9	1974	2 13.3	19016.3	45245.6	19002.0	737.1	67 12.2	49079.3
10	1975	2 16.4	19035.2	45273.5	19020.2	754.9	67 11.7	49112.4
11	1976	2 18.5	19049.7	45306.9	19034.3	767.3	67 11.7	49148.8
12	1977	2 22.0	19062.1	45336.6	19045.8	787.4	67 11.7	49181.0
13	1978	2 27.4	19058.6	45375.7	19041.1	817.1	67 13.0	49215.7
14	1979	2 32.3	19061.4	45401.4	19042.7	844.2	67 13.5	49240.5
15	1980	2 37.2	19063.2	45418.4	19043.3	871.2	67 13.9	49256.8
16	1981	2 42.9	19047.1	45448.9	19025.7	902.0	67 15.7	49278.7
17	1982	2 48.3	19034.8	45478.8	19012.0	931.3	67 17.3	49301.6
18	1983	2 52.4	19032.6	45498.8	19008.7	953.8	67 18.0	49319.2
19	1984	2 56.9	19022.8	45519.8	18997.6	978.4	67 19.2	49334.8
20	1985	3 00.8	19015.2	45542.0	18988.9	999.5	67 20.3	49352.3
21	1986	3 05.1	19003.3	45570.4	18975.8	1022.8	67 21.8	49373.9
22	1987	3 08.5	18999.1	45592.7	18970.6	1041.2	67 22.7	49392.9
23	1988	3 12.4	18983.0	45626.4	18953.3	1062.0	67 24.6	49417.8
24	1989	3 15.9	18966.2	45662.1	18935.4	1080.3	67 26.6	49444.3
25	1990	3 18.8	18961.5	45684.3	18929.8	1095.9	67 27.5	49463.1
26	1991	3 22.2	18950.8	45709.3	18918.0	1114.1	67 28.8	49482.0
27	1992	3 25.3	18954.8	45726.1	18921.0	1131.2	67 29.1	49499.1
28	1993	3 29.8	18956.4	45743.7	18921.1	1156.0	67 29.4	49516.0
29	1994	3 34.8	18953.6	45772.4	18916.6	1183.3	67 30.4	49541.4
30	1995	3 39.8	18959.3	45796.8	18920.6	1211.5	67 30.7	49566.2
31	1996	3 45.0	18965.7	45821.9	18925.1	1240.6	67 30.9	49591.8
32	1997	3 50.9	18962.8	45856.9	18920.0	1272.7	67 32.0	49623.0
33	1998	3 57.3	18955.8	45897.1	18910.6	1307.6	67 33.6	49657.5
34	1999	4 02.5	18957.8	45930.6	18910.6	1336.4	67 34.3	49689.2
35	2000	4 07.8	18955.4	45968.7	18906.2	1365.4	67 35.5	49723.5
36	2001	4 13.0	18962.4	46004.8	18911.1	1394.2	67 36.0	49759.6
37	2002	4 18.4	18969.2	46043.6	18915.6	1424.4	67 36.6	49798.0
38	2003	4 24.2	18970.2	46089.6	18914.2	1456.7	67 37.7	49840.9
39	2004	4 29.4	18980.3	46121.0	18922.0	1486.0	67 37.9	49873.8
40	2005	4 34.7	18984.3	46154.6	18923.7	1515.5	67 38.5	49906.4
41	2006	4 39.8	18996.7	46177.2	18933.8	1544.3	67 38.3	49932.0
42	2007	4 45.8	19007.4	46206.7	18941.8	1578.4	67 38.4	49963.4
43	2008	4 52.5	19014.0	46236.3	18945.2	1615.9	67 38.7	49993.3

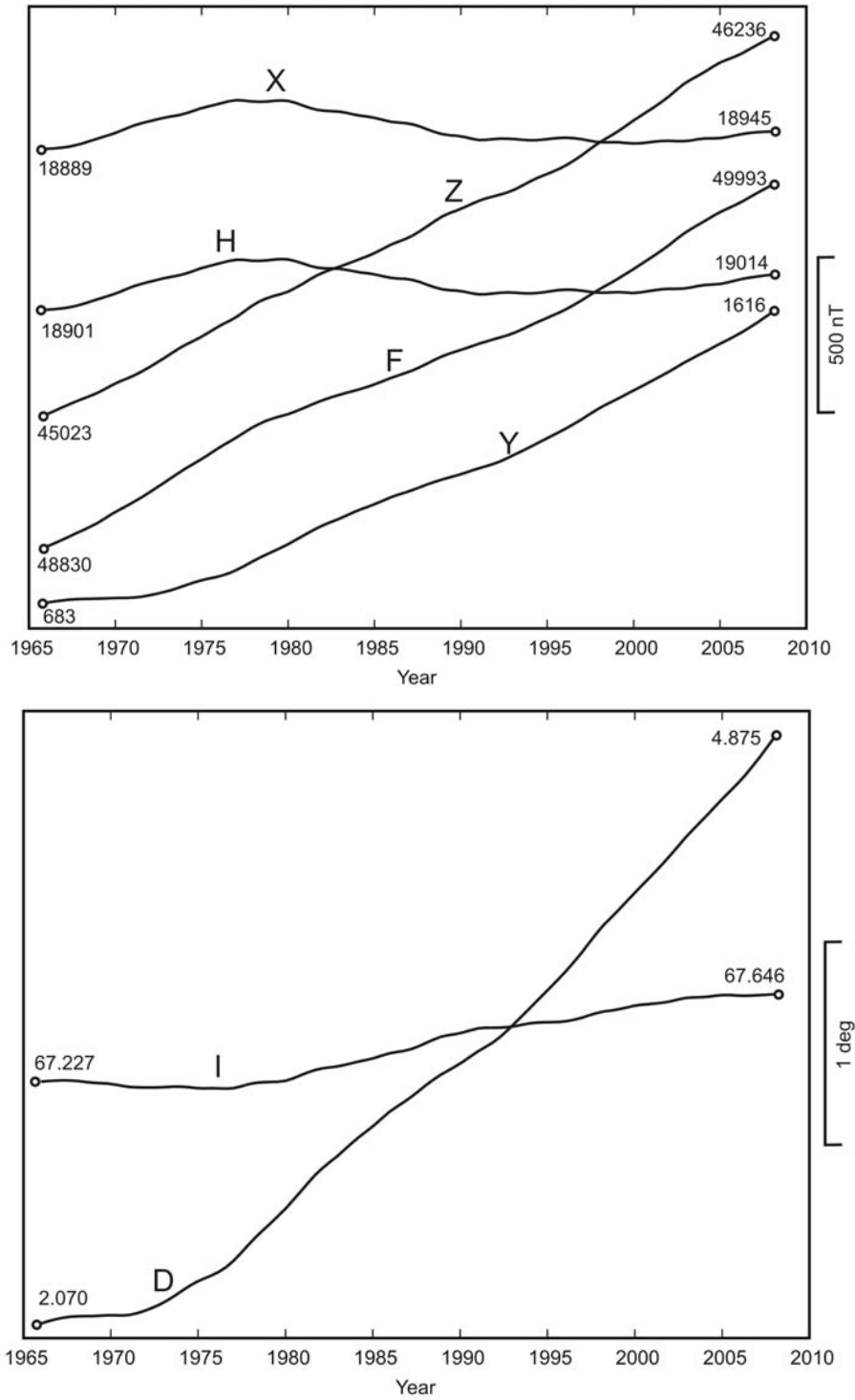

Fig. 10. Secular changes of H, X, Y, Z, F, D and I at Belsk.

MONTHLY AND YEARLY MEAN VALUES OF MAGNETIC ELEMENTS

BELSK

2008

JAN FEB MAR APR MAY JUN JUL AUG SEP OCT NOV DEC MEAN

NORTH COMPONENT: 18500 + ... in nT

All days	443	440	438	442	450	450	450	448	446	443	446	447	445
Quiet days	450	447	445	444	454	452	451	450	447	448	448	450	449
Disturbed days	437	435	429	436	447	451	446	445	441	437	441	442	441

EAST COMPONENT: 1500 + ... in nT

All days	98	103	106	108	110	114	117	120	123	127	130	133	116
Quiet days	96	101	104	107	110	114	116	119	123	126	129	131	115
Disturbed days	100	108	111	110	111	113	118	122	124	129	131	135	118

VERTICAL COMPONENT: 46000 + ... in nT

All days	223	228	231	231	231	234	237	238	241	246	247	250	236
Quiet days	221	227	229	230	229	233	236	238	241	245	246	249	235
Disturbed days	223	228	231	233	232	233	238	239	241	247	247	250	237

Three-hour-range K indices
Belsk, January - March, 2008
The limit of K=9 is 450

Day	January			February			March		
	K	SK		K	SK		K	SK	
1	2201	1011	8	3232	2455	26	5333	4443	29
2	0111	1120	7	4422	3343	25	2232	2333	20
3	0101	1012	6	3223	2453	24	1223	1221	14
4	0000	1112	5	3212	1234	18	2011	1101	7
5	2234	4354	27	1211	1210	9	2222	3331	18
6	3332	3454	27	0111	1232	11	1111	0112	8
7	3333	3223	22	3200	1223	13	2110	1122	10
8	2223	2443	22	4111	1232	15	0012	4331	14
9	3222	1122	15	1011	2123	11	3533	3434	28
10	2111	2212	12	0223	4545	25	3323	3444	26
11	2111	1120	9	3323	4433	25	2232	4432	22
12	0012	3422	14	3222	3333	21	3332	3243	23
13	3111	2342	17	2232	4432	22	2223	4223	20
14	3224	3453	26	2122	3143	18	3322	2434	23
15	2222	3222	17	2223	3332	20	4223	2222	19
16	2233	3333	22	3222	2230	16	2211	2323	16
17	3212	4234	21	0122	2113	12	2211	1321	13
18	3322	2332	20	1112	5434	21	3312	2211	15
19	1223	3522	20	3232	3332	21	0121	3333	16
20	1221	2132	14	1321	1201	11	2112	3333	18
21	1112	2233	15	1112	3331	15	2112	0232	13
22	1111	1110	7	1111	2111	9	2010	2123	11
23	0012	2133	12	1111	1232	12	3332	2222	19
24	1111	2232	13	1011	1222	10	1111	1111	8
25	3322	1142	18	2111	1110	8	1011	2223	12
26	3222	1213	16	0111	1122	9	1233	4454	26
27	1101	1232	11	1111	2352	16	4533	3555	33
28	1101	1123	10	3323	2555	28	4343	4443	29
29	1222	1100	9	5233	3655	32	2212	2334	19
30	1111	1000	5				3222	2223	18
31	0011	2333	13				2101	2121	10

Three-hour-range K indices
Belsk, April - June, 2008
The limit of K=9 is 450

Day	April			May			June		
	K	SK		K	SK		K	SK	
1	1212	1110	9	1211	1334	16	2212	2421	16
2	0101	0011	4	5321	3111	17	2211	3221	14
3	2101	1201	8	3233	4233	23	0102	2322	12
4	0011	2444	16	1223	2333	19	2111	2101	9
5	2223	2534	23	2231	3442	21	1102	1210	8
6	3343	3234	25	3222	2122	16	1223	2232	17
7	3322	1443	22	2111	2222	13	2233	3233	21
8	2213	4233	20	2112	2221	13	3212	4312	18
9	3233	3233	22	1111	2112	10	2111	1021	9
10	3222	3233	20	1211	1122	11	1101	2210	8
11	3112	2211	13	2112	2121	12	1122	1011	9
12	3223	3243	22	0111	1221	9	1221	1212	12
13	2112	3421	16	2211	1220	11	1100	1120	6
14	1100	0110	4	0112	2121	10	1111	2445	19
15	0111	3223	13	0111	1121	8	4423	3324	25
16	2223	4353	24	1212	2221	13	2223	3344	23
17	3211	2321	15	1001	1101	5	2223	3322	19
18	2222	2222	16	0112	3111	10	3322	2211	16
19	2211	1223	14	2223	3331	19	1113	3222	15
20	2111	1221	11	2222	2333	19	2333	2222	19
21	1111	1211	9	3332	3322	21	1111	2212	11
22	0111	1323	12	3221	3432	20	2112	2111	11
23	3443	3434	28	2102	3233	16	2111	1110	8
24	3334	3223	23	4222	2322	19	1001	1233	11
25	2222	3232	18	2211	2212	13	3221	2333	19
26	3122	2433	20	1212	0111	9	3333	4322	23
27	2222	2322	17	1011	2222	11	3213	3321	18
28	1123	4444	23	3232	4423	23	1212	2222	14
29	3221	1121	13	2222	3432	20	2213	2223	17
30	0111	1452	15	3222	3442	22	1212	2221	13
31				1223	3332	19			

Three-hour-range K indices
Belsk, July - September, 2008
The limit of K=9 is 450

Day	July			August			September		
	K	SK		K	SK		K	SK	
1	2112	2111	11	1110	1222	10	1111	1111	8
2	2111	1010	7	0111	1111	7	1111	1111	8
3	1101	2211	9	1111	1222	11	1223	1334	19
4	0111	2321	11	1111	2111	9	5633	3433	30
5	2112	3333	18	1011	1110	6	2212	2123	15
6	2111	1111	9	1112	2222	13	3222	3233	20
7	1121	1102	9	1101	1222	10	3221	3241	18
8	0011	1111	6	1001	1212	8	1232	2343	20
9	0111	1111	7	3333	3445	28	1221	1113	12
10	0112	2222	12	3332	2332	21	1111	1231	11
11	2122	3223	17	2222	3212	16	0010	1112	6
12	3433	4232	24	1221	2322	15	1111	1010	6
13	2233	3432	22	2111	1211	10	0000	0001	1
14	2223	3423	21	2211	2210	11	0011	1144	12
15	3222	2222	17	2111	0110	7	3233	4433	25
16	2111	1222	12	1111	1223	12	1223	1432	18
17	2211	1220	11	3212	2212	15	3101	0011	7
18	1111	2111	9	2323	5343	25	2223	2211	15
19	1001	1101	5	3222	3331	19	0111	2231	11
20	1111	1121	9	2212	2110	11	1110	1100	5
21	1221	2222	14	1011	1121	8	1000	1112	6
22	1123	4333	20	1111	1111	8	3200	0101	7
23	3323	4333	24	1100	1111	6	2011	1111	8
24	3222	2222	17	0001	1012	5	1112	1100	7
25	1202	1101	8	1010	1001	4	1001	0133	9
26	2212	2221	14	1111	1111	8	2101	1100	6
27	0112	2124	13	2111	2011	9	0011	1232	10
28	2221	1211	12	1101	1222	10	0012	2110	7
29	0111	1212	9	1110	1211	8	0111	1111	7
30	1212	1222	13	0111	0100	4	0111	2223	12
31	1111	2211	10	0022	2232	13			

Three-hour-range K indices
Belsk, October - December, 2008
The limit of K=9 is 450

Day	October			November			December		
	K	SK		K	SK		K	SK	
1	2222	2233	18	1111	0121	8	0000	0000	0
2	3323	4343	25	0011	1012	6	0000	1000	1
3	3232	3333	22	0101	0111	5	0111	1222	10
4	2323	2213	18	1010	0001	3	2322	3312	18
5	2211	1112	11	0000	0000	0	2212	2525	21
6	1211	0101	7	0000	1010	2	3422	2432	22
7	0001	1120	5	0222	3235	19	2222	3322	18
8	1100	0001	3	3223	3232	20	1110	1231	10
9	0010	1000	2	4222	2233	20	0000	0100	1
10	0111	1103	8	1111	1210	8	0001	1222	8
11	2143	5753	30	0111	0100	4	2211	1221	12
12	4323	2324	23	1011	1111	7	1011	1112	8
13	3222	1232	17	1001	1000	3	2111	0011	7
14	1111	1221	10	0001	0111	4	1000	0000	1
15	3222	1122	15	2110	0123	10	0111	0112	7
16	1111	0111	7	3322	2133	19	1111	2133	13
17	0000	1100	2	2120	0011	7	3211	1221	13
18	0000	0011	2	1000	0110	3	0000	1121	5
19	1112	2333	16	0001	0110	3	1101	2212	10
20	1010	1122	8	0100	0022	5	1001	1110	5
21	2211	1112	11	1001	0010	3	0111	0100	4
22	0011	1233	11	0001	0011	3	0000	1432	10
23	2111	1111	9	2110	0010	5	2222	2344	21
24	0110	0000	2	0000	0013	4	2122	1332	16
25	0001	1111	5	3333	3232	22	1001	2131	9
26	0211	1201	8	3322	2233	20	1100	1122	8
27	1011	0000	3	2222	2233	18	2001	1011	6
28	0122	1222	12	1211	1123	12	2011	1111	8
29	2342	2444	25	1111	0122	9	1001	0101	4
30	3223	2543	24	1011	0210	6	0000	0011	2
31	2222	1233	17				3323	2232	20

Three-hour-range E indices
based on power spectrum estimation(*)
Belsk, January - March, 2008

Day	January			February			March		
	K	SE		K	SE		K	SE	
1	2201	1001	7	3232	1465	26	6433	5543	33
2	0011	0120	5	4422	4354	28	2233	2334	22
3	0000	0011	2	3224	3554	28	1222	1221	13
4	0000	0012	3	3212	1223	16	2011	1000	5
5	2344	4455	31	1100	0210	5	2212	4341	19
6	4433	4554	32	0001	1242	10	1101	0112	7
7	4332	3123	21	3200	0312	11	1110	0012	6
8	2223	2544	24	4111	1122	13	0002	5341	15
9	4222	1122	16	1001	2123	10	4634	4435	33
10	2101	2212	11	0224	5655	29	4323	3455	29
11	3111	0020	8	3424	4443	28	3142	5532	25
12	0011	2433	14	3323	4443	26	3342	4153	25
13	3111	3452	20	2242	5431	23	2223	4233	21
14	4225	3564	31	2112	4153	19	2322	3544	25
15	2222	3233	19	2223	4442	23	4123	3223	20
16	2333	3433	24	2322	3140	17	2211	2213	14
17	3212	4234	21	0112	2013	10	2100	0321	9
18	3322	2443	23	1013	4444	21	2311	2210	12
19	1123	3532	20	3242	3341	22	0021	3444	18
20	1321	2033	15	1322	1301	13	2112	4333	19
21	1112	2233	15	1112	3331	15	2111	0233	13
22	1100	1110	5	1011	2000	5	2000	1014	8
23	0012	1142	11	0111	1342	13	4333	2222	21
24	1101	2241	12	1011	0123	9	0011	1110	5
25	3322	1152	19	2111	1100	7	0011	1113	8
26	4222	2203	17	0101	0122	7	2243	4465	30
27	1101	1143	12	2211	2353	19	5533	3556	35
28	0101	1024	9	4324	2666	33	5353	4444	32
29	1212	1000	7	5234	4755	35	2322	2334	21
30	1100	0000	2				3122	2223	17
31	0001	1344	13				1101	2121	9

* - see literature: Reda and Jankowski, 2004

Three-hour-range E indices
based on power spectrum estimation(*)
Belsk, April - June, 2008

Day	April			May			June		
	K	SE		K	SE		K	SE	
1	1211	0100	6	1111	1235	15	2212	2432	18
2	0100	0010	2	5221	3101	15	1201	2221	11
3	1001	1100	4	3223	4243	23	0201	1222	10
4	0001	2455	17	1123	1333	17	2110	1100	6
5	1113	2635	22	2231	3443	22	0001	1200	4
6	3443	3244	27	4122	1122	15	0122	2132	13
7	4321	1544	24	2001	1122	9	2143	3343	23
8	1113	4234	19	2111	1121	10	4212	3312	18
9	3233	3233	22	1011	1011	6	2001	0021	6
10	3212	3232	18	1111	1112	9	1001	1110	5
11	3102	2301	12	1111	2120	9	1122	1000	7
12	3323	3243	23	0000	1121	5	0211	1112	9
13	1112	3531	17	2200	1220	9	0100	1110	4
14	1100	0000	2	0101	2110	6	1001	2346	17
15	0011	2224	12	0111	1011	6	4433	3324	26
16	3123	4353	24	1112	2211	11	2223	3344	23
17	4211	1210	12	1001	0000	2	3223	3432	22
18	2122	1112	12	0001	2110	5	4422	2100	15
19	2111	0224	13	3123	3331	19	1002	3222	12
20	2011	1321	11	2222	3334	21	2443	2222	21
21	1101	0110	5	4422	3322	22	1111	2112	10
22	0001	0333	10	3111	2442	18	1111	2000	6
23	3444	4544	32	2102	3243	17	2100	0000	3
24	4443	4223	26	4112	2312	16	0000	1123	7
25	2222	2232	17	2211	2212	13	4221	2433	21
26	3122	2434	21	1111	0101	6	4334	3331	24
27	2222	2311	15	0011	1223	10	4213	2411	18
28	1113	3543	21	3332	4423	24	0102	2232	12
29	3210	1121	11	2222	3432	20	2213	2234	19
30	0001	0452	12	4112	3542	22	1111	2230	11
31				0123	4342	19			

* - see literature: Reda and Jankowski, 2004

Three-hour-range E indices
based on power spectrum estimation(*)
Belsk, August - September, 2008

Day	July			August			September		
	K	SE		K	SE		K	SE	
1	2111	2101	9	0000	1112	5	1000	1110	4
2	2001	1010	5	0000	1011	3	0011	1101	5
3	0001	2210	6	0011	1223	10	1123	1334	18
4	0010	2211	7	1001	1111	6	6633	3533	32
5	1112	4333	18	0011	1100	4	2312	3123	17
6	2120	1010	7	1112	1222	12	4212	3243	21
7	1111	0002	6	1101	1122	9	4211	3251	19
8	0002	1111	6	0000	1202	5	1222	2453	21
9	0001	1111	5	3333	3556	31	1211	0004	9
10	0002	2112	8	4431	1432	22	1000	1130	6
11	1112	4213	15	3112	3212	15	0000	0013	4
12	3444	4332	27	1221	2312	14	1000	0000	1
13	2223	3443	23	3101	1111	9	0000	0001	1
14	2223	3423	21	3311	2110	12	0011	0144	11
15	3221	1223	16	3101	0010	6	3234	4443	27
16	1111	1222	11	0111	1124	11	1323	1432	19
17	3111	1110	9	3112	3212	15	3100	0001	5
18	0111	1110	6	2324	5453	28	2213	2211	14
19	0001	1001	3	3222	2431	19	0100	2230	8
20	1001	0021	5	2112	1100	8	1100	0100	3
21	2111	2222	13	0001	1021	5	0000	0112	4
22	0123	4434	21	1110	0100	4	3200	0100	6
23	3422	5442	26	1000	1001	3	2011	1001	6
24	4222	2221	17	0000	1002	3	0012	1000	4
25	0102	1001	5	0000	0000	0	0001	0133	8
26	2102	1221	11	0000	1110	3	2100	1000	4
27	0012	1125	12	2111	1000	6	0000	1132	7
28	2221	1100	9	0000	1112	5	0011	2100	5
29	0001	1112	6	1010	1110	5	0011	1001	4
30	1201	1121	9	0011	0000	2	0010	1223	9
31	0111	1211	8	0001	1221	7			

* - see literature: Reda and Jankowski, 2004

Three-hour-range E indices
based on power spectrum estimation(*)
Belsk, October - December, 2008

Day	October			November			December		
	K	SE		K	SE		K	SE	
1	2122	2234	18	1010	0110	4	0000	0000	0
2	3323	4343	25	0011	1012	6	0000	0000	0
3	3233	4344	26	0000	0000	0	0001	1222	8
4	2423	2203	18	1000	0000	1	1422	3312	18
5	1211	1002	8	0000	0000	0	2113	2625	22
6	0110	0000	2	0000	0020	2	4532	2532	26
7	0000	0120	3	0222	2236	19	2222	3322	18
8	1100	0000	2	4323	3242	23	0100	1230	7
9	0000	0000	0	4222	1234	20	0000	0000	0
10	0001	1103	6	2101	1200	7	0000	1221	6
11	2144	6754	33	0100	0000	1	2112	1221	12
12	5333	3424	27	1010	0012	5	1001	1111	6
13	4222	1232	18	0000	0000	0	2101	0000	4
14	1011	1221	9	0000	0100	1	1000	0000	1
15	3322	1122	16	1100	0113	7	0110	0012	5
16	1001	0010	3	3321	2013	15	0011	1244	13
17	0000	1100	2	2110	0011	6	2210	1210	9
18	0000	0010	1	0000	0000	0	0000	1121	5
19	1112	2234	16	0000	0010	1	0001	2212	8
20	1000	1122	7	0000	0012	3	0001	1100	3
21	2111	1012	9	0000	0000	0	0110	0000	2
22	0000	1343	11	0000	0000	0	0000	0432	9
23	1010	0000	2	1110	0010	4	2222	2455	24
24	0000	0000	0	0000	0001	1	2222	1332	17
25	0000	0011	2	4332	2342	23	0001	3131	9
26	0221	1202	10	3321	1234	19	1000	1011	4
27	0000	0000	0	3212	2242	18	2000	0011	4
28	0022	1221	10	1211	0124	12	2001	0000	3
29	3242	2544	26	0011	0112	6	0001	0000	1
30	3223	2543	24	1000	0200	3	0000	0011	2
31	1221	1133	14				3334	2342	24

* - see literature: Reda and Jankowski, 2004

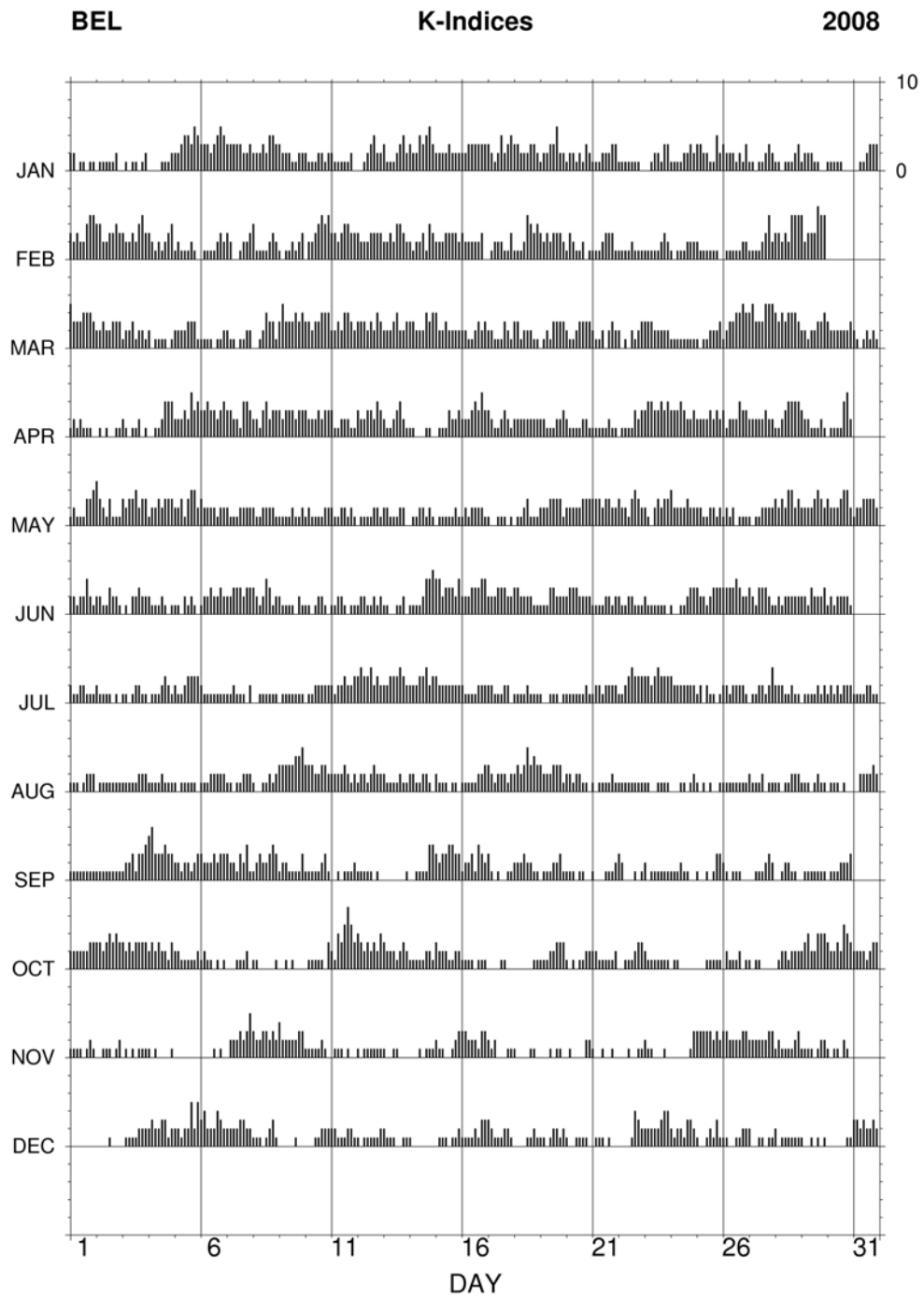

Fig. 11. K-indices in graphical form, Belsk 2008.

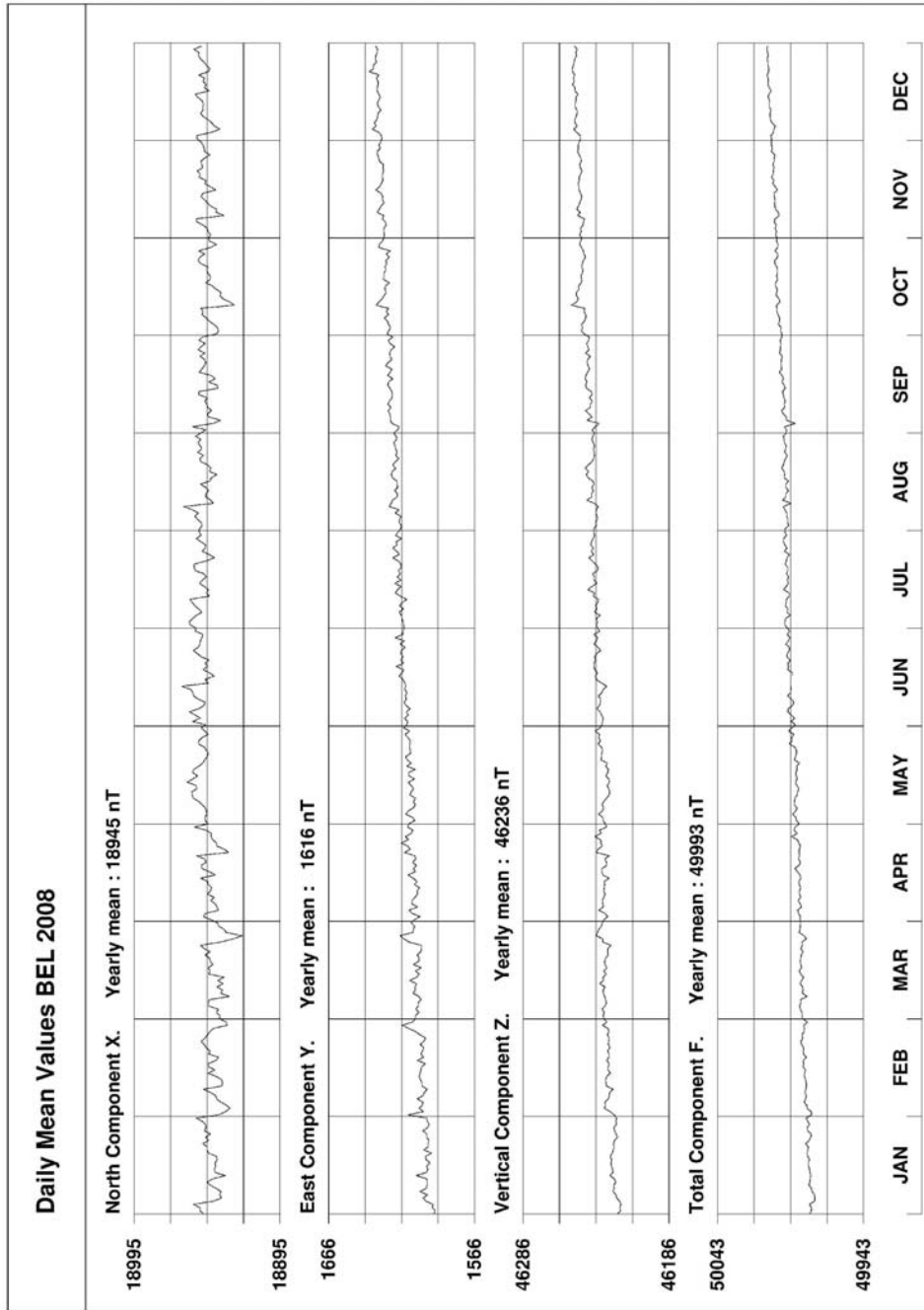

Fig. 12. Daily mean data plot for Belsk 2008.

BEL - Hourly Mean Values

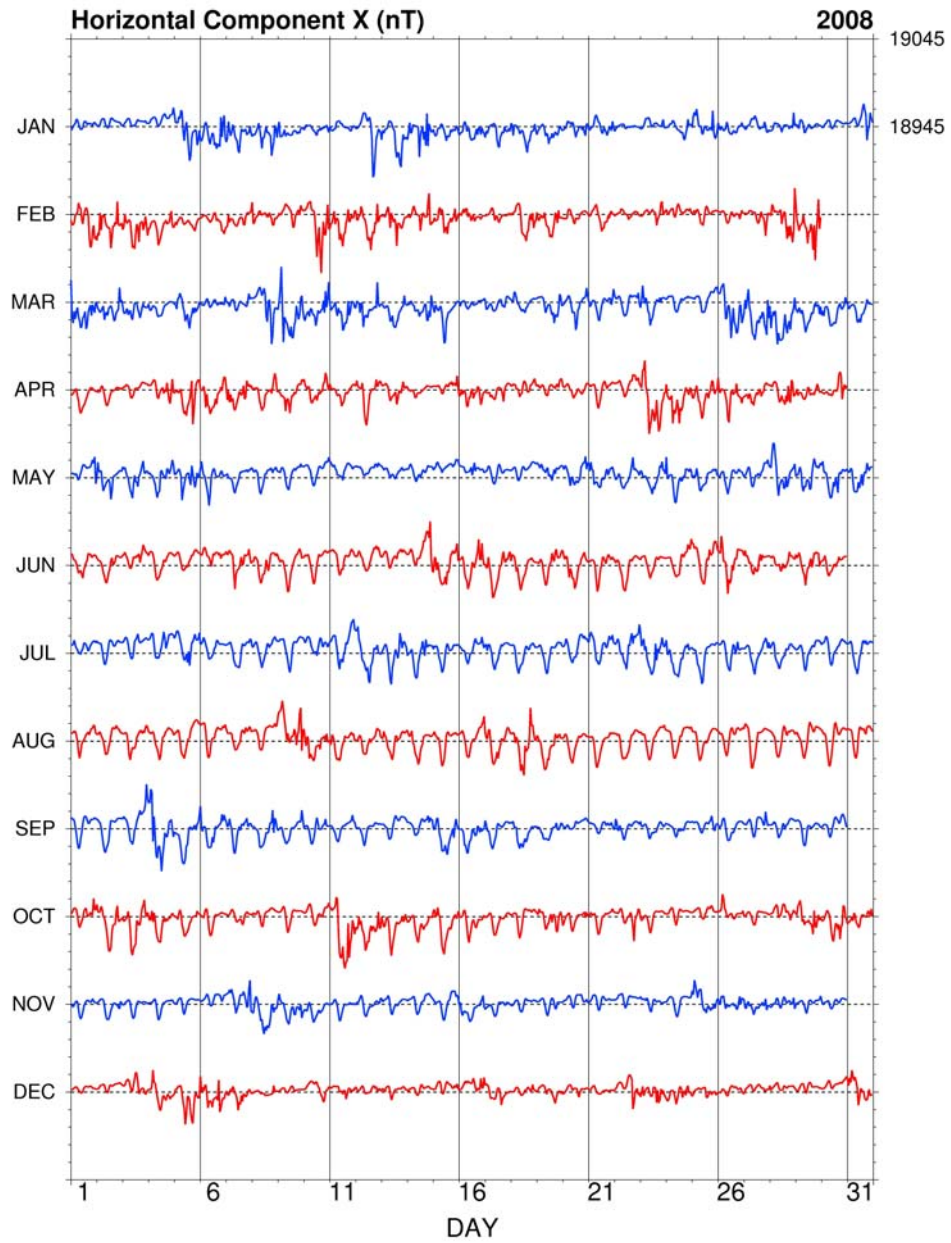

Fig. 13. Hourly mean data plot of X component for Belsk 2008.

BEL - Hourly Mean Values

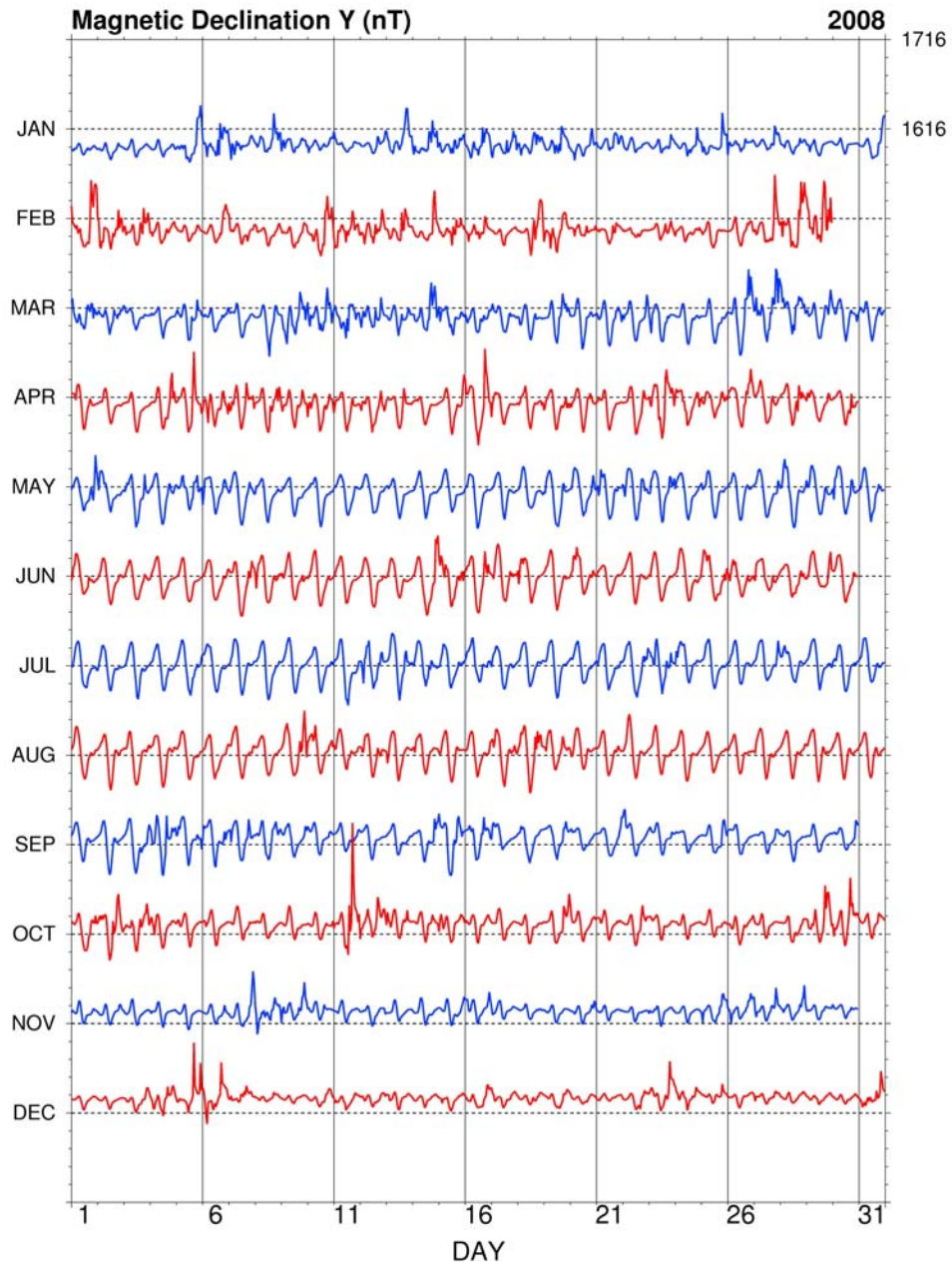

Fig. 14. Hourly mean data plot of Y component for Belsk 2008.

BEL - Hourly Mean Values

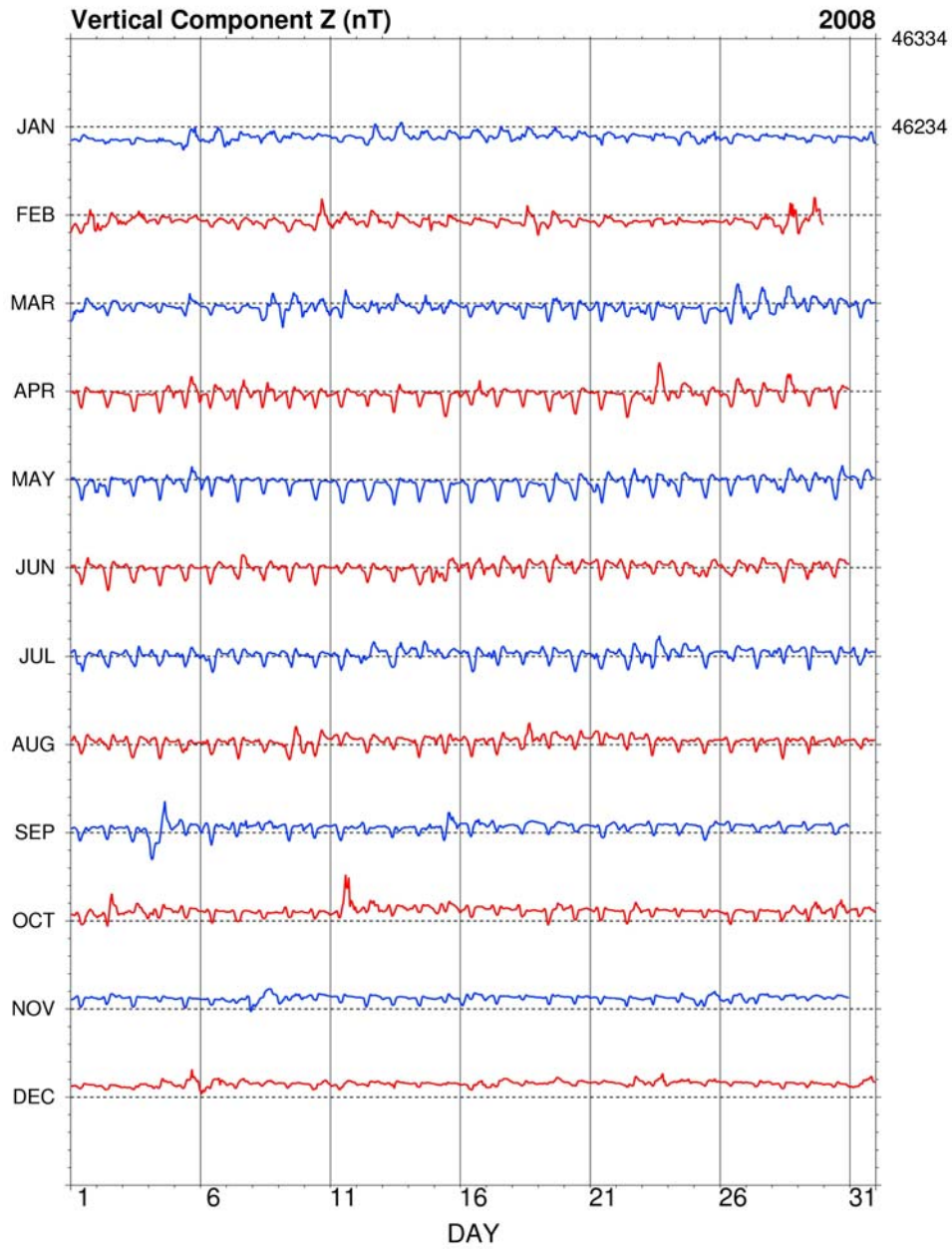

Fig. 15. Hourly mean data plot of Z component for Belsk 2008.

BEL - Hourly Mean Values

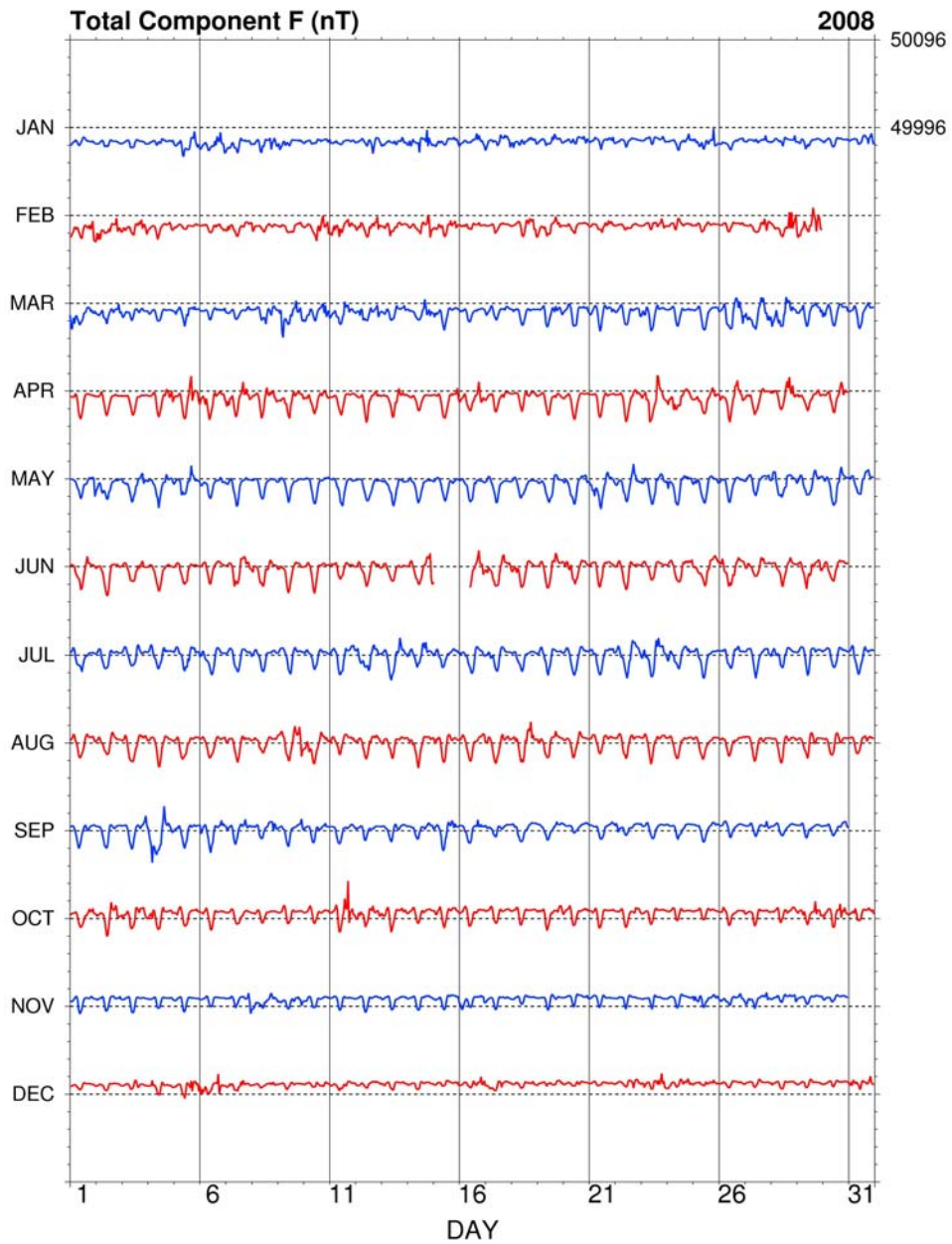

Fig. 16. Hourly mean data plot of F component for Belsk 2008.

Tables and plots for Hel Observatory

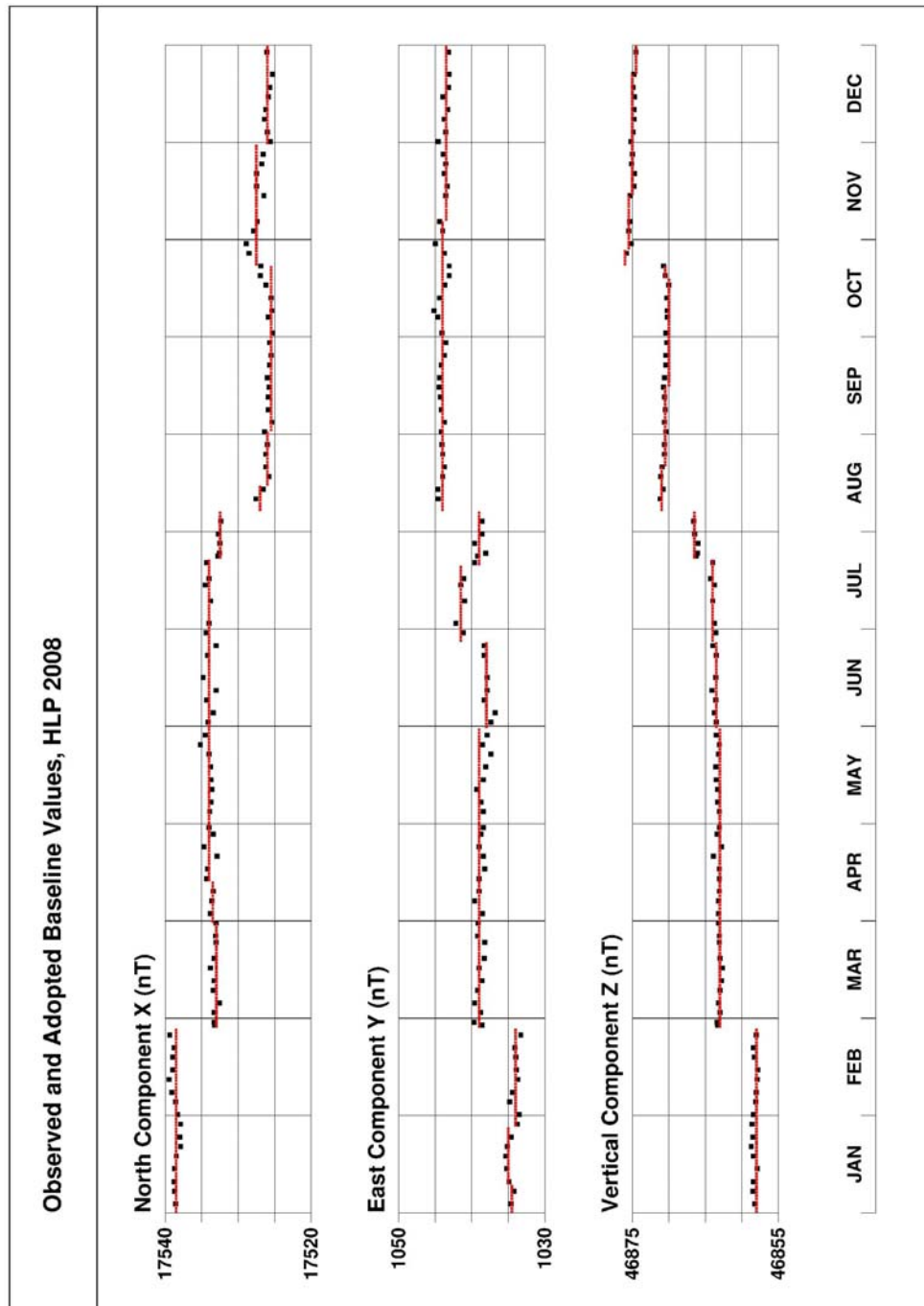

Fig. 17. Base values of set 1, Hel 2008.

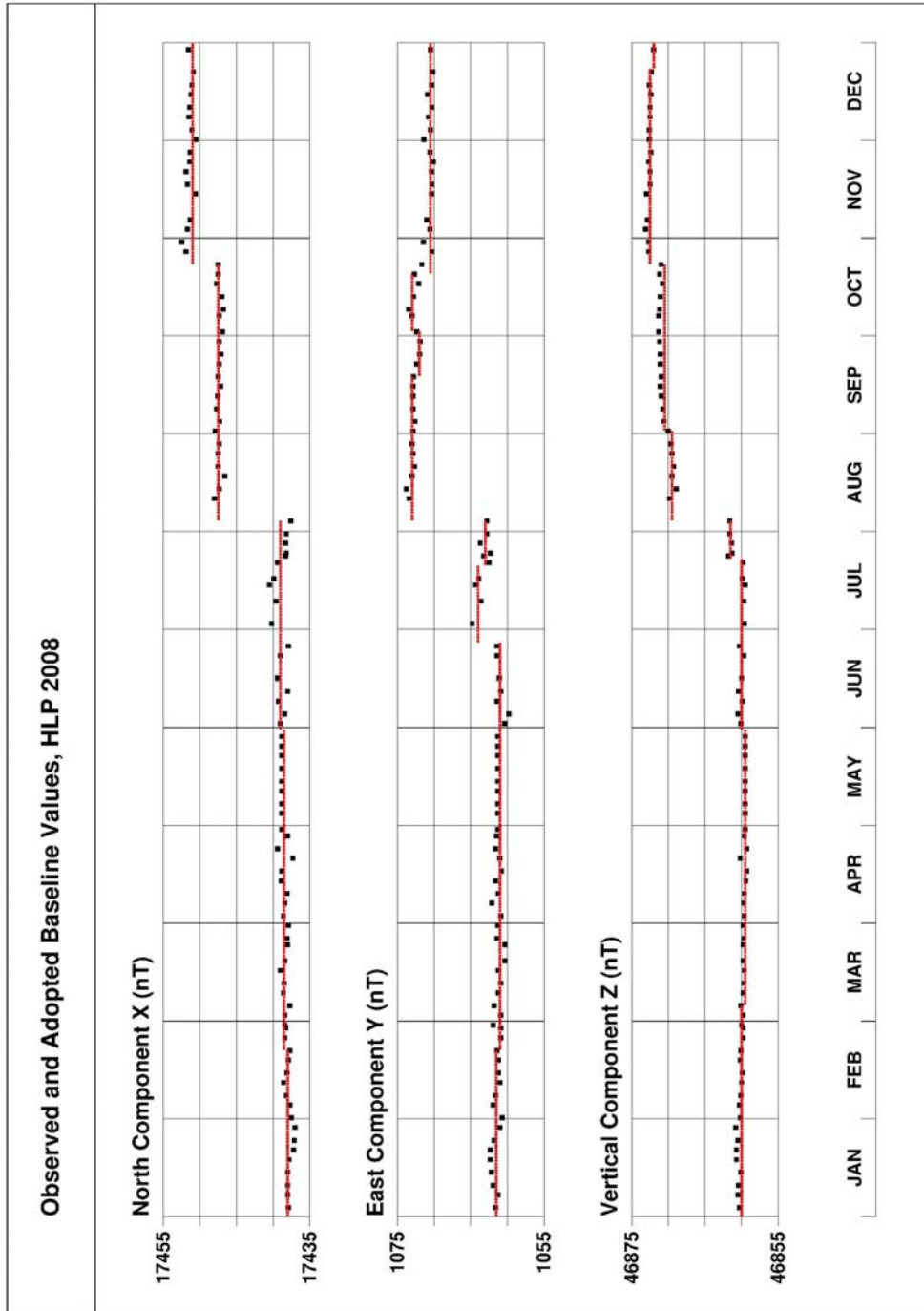

Fig. 18. Base values of set 2, Hel 2008.

Annual mean values of magnetic elements in Hel Observatory

No	Year	D [° ']	H [nT]	Z [nT]	X [nT]	Y [nT]	I [° ']	F [nT]
1	1953	-0 14.5	17388	45327	17388	-73	69 00.8	48548
2	1954	-0 10.0	17394	45374	17394	-51	69 01.5	48594
3	1955	-0 04.2	17379	45430	17379	-21	69 03.9	48640
4	1956	0 03.9	17371	45450	17371	20	69 05.0	48656
5	1957	0 05.7	17372	45475	17372	29	69 05.5	48680
6	1958	0 10.2	17380	45535	17380	52	69 06.5	48739
7	1959	0 14.7	17390	45565	17390	74	69 06.6	48771
8	1960	0 17.6	17402	45602	17402	89	69 06.8	48810
9	1961	0 19.8	17422	45625	17422	100	69 06.0	48838
10	1962	0 22.7	17438	45647	17438	115	69 05.5	48864
11	1963	0 26.5	17449	45663	17448	134	69 05.2	48883
12	1964	0 28.6	17464	45676	17463	145	69 04.6	48901
13	1965	0 30.0	17476	45692	17475	152	69 04.2	48920
14	1966	0 31.6	17485	45710	17484	161	69 04.0	48940
15	1967	0 33.3	17492	45743	17491	169	69 04.4	48973
16	1968	0 34.4	17502	45769	17501	175	69 04.4	49001
17	1969	0 34.3	17524	45792	17523	175	69 03.5	49030
18	1970	0 34.8	17542	45824	17541	178	69 03.2	49067
19	1971	0 35.7	17565	45849	17564	182	69 02.3	49098
20	1972	0 36.1	17579	45880	17578	184	69 02.1	49132
21	1973	0 38.5	17595	45912	17594	197	69 01.9	49168
22	1974	0 41.9	17606	45951	17605	215	69 02.2	49208
23	1975	0 45.0	17625	45984	17623	231	69 01.7	49246
24	1976	0 49.6	17639	46015	17637	254	69 01.6	49280
25	1977	0 55.0	17651	46045	17649	282	69 01.5	49312
26	1978	1 00.2	17646	46085	17643	309	69 02.9	49349
27	1979	1 05.1	17651	46112	17648	334	69 03.2	49375
28	1980	1 11.5	17653	46127	17649	367	69 03.5	49390
29	1981	1 17.5	17637	46156	17632	398	69 05.2	49411
30	1982	1 23.4	17620	46184	17615	427	69 07.1	49431
31	1983	1 28.6	17614	46200	17608	454	69 07.8	49444
32	1984	1 33.5	17602	46219	17596	479	69 09.1	49457
33	1985	1 37.9	17591	46239	17584	501	69 10.3	49472
34	1986	1 42.7	17579	46263	17571	525	69 11.6	49490
35	1987	1 46.3	17572	46285	17564	543	69 12.6	49508
36	1988	1 51.0	17555	46318	17546	567	69 14.6	49533

No	Year	D [° ‘]	H [nT]	Z [nT]	X [nT]	Y [nT]	I [° ‘]	F [nT]
37	1989	1 55.5	17535	46352	17525	589	69 16.7	49558
38	1990	1 58.4	17527	46374	17516	604	69 17.8	49575
39	1991	2 00.6	17513	46398	17502	614	69 19.3	49593
40	1992	2 03.9	17515	46416	17504	631	69 19.6	49611
41	1993	2 10.0	17516	46428	17503	662	69 19.8	49622
42	1994	2 15.9	17512	46456	17498	692	69 20.7	49647
43	1995	2 21.3	17518	46481	17503	720	69 21.0	49672
44	1996	2 26.6	17523	46506	17507	747	69 21.2	49698
45	1997	2 32.9	17519	46539	17502	779	69 22.3	49727
46	1998	2 39.8	17512	46581	17493	814	69 23.8	49764
47	1999	2 45.4	17511	46615	17491	842	69 24.7	49796
48	2000	2 51.9	17507	46657	17485	875	69 25.9	49833
49	2001	2 57.7	17515	46692	17492	905	69 26.2	49869
50	2002	3 03.7	17520	46730	17495	936	69 26.9	49906
51	2003	3 10.8	17519	46777	17492	972	69 28.1	49950
52	2004	3 16.6	17529	46809	17500	1002	69 28.2	49983
53	2005	3 22.3	17531	46843	17501	1031	69 28.9	50016
J	2006.0	0 -1.5	-2	9	-2	-8	0 0.6	7
54	2006	3 29.9	17550	46859	17517	1071	69 28.1	50038
55	2007	3 36.7	17559	46887	17524	1106	69 28.2	50067
56	2008	3 43.8	17564	46917	17527	1143	69 28.5	50097

Note: Since 2006 the observatory has stopped introducing the so-called historical corrections. The corrections were related, among other things, with the variable location of the instruments for absolute measurements. In the 2006.0 line we include the jump value J relating to the neglect of historical corrections. The jump values are defined as follows:

$$\text{jump value J} = \text{old site value} - \text{new site value}$$

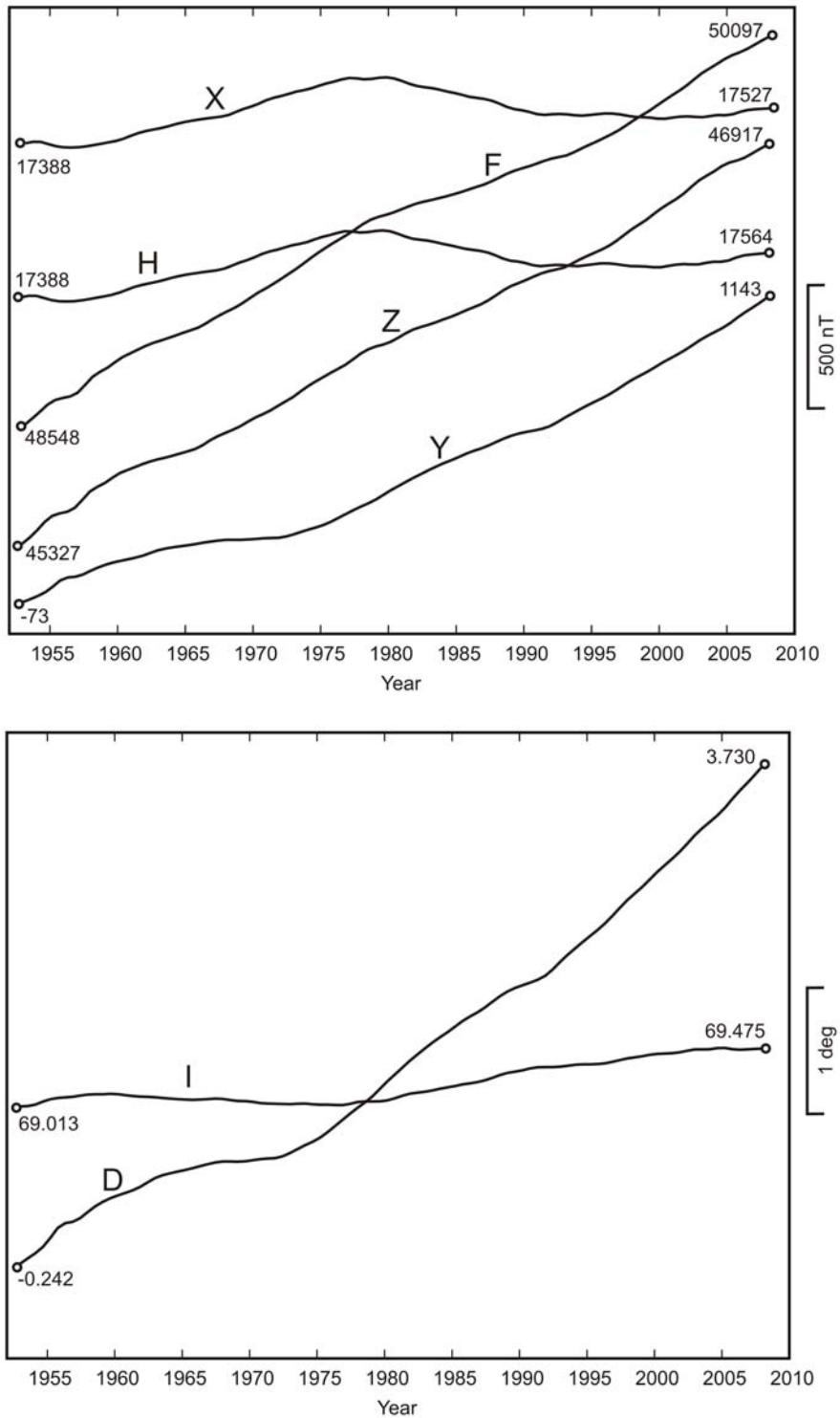

Fig. 19. Secular changes of H, X, Y, Z, F, D and I at Hel.

MONTHLY AND YEARLY MEAN VALUES OF MAGNETIC ELEMENTS

HEL 2008

	JAN	FEB	MAR	APR	MAY	JUN	JUL	AUG	SEP	OCT	NOV	DEC	MEAN
--	-----	-----	-----	-----	-----	-----	-----	-----	-----	-----	-----	-----	------

NORTH COMPONENT: 17000 + ... in nT

All days	524	522	521	525	532	531	532	529	527	525	529	529	527
Quiet days	530	528	527	526	535	533	530	532	530	520	529	531	529
Disturbed days	519	517	512	519	530	532	530	527	524	524	528	530	524

EAST COMPONENT: 1000 + ... in nT

All days	127	131	133	135	136	140	144	146	150	154	157	161	143
Quiet days	124	128	130	134	136	139	142	146	150	157	158	160	142
Disturbed days	129	136	137	138	137	139	142	146	150	153	157	161	144

VERTICAL COMPONENT: 46500 + ... in nT

All days	404	409	412	412	412	415	417	419	422	427	428	431	417
Quiet days	402	408	410	411	410	415	419	418	422	428	428	431	417
Disturbed days	404	408	411	414	413	413	419	420	423	427	429	432	418

Three-hour-range K indices**Hel, January - March, 2008****The limit of K=9 is 550**

Day	January			February			March		
	K		SK	K		SK	K		SK
1	2101	1001	6	3222	1355	23	5323	4433	27
2	0000	1120	4	4322	3243	23	2222	2323	18
3	0000	0011	2	3223	2443	23	2123	1111	12
4	0000	1112	5	3212	1233	17	2011	1001	6
5	2233	3354	25	1101	1210	7	2212	3231	16
6	3332	3443	25	0011	1232	10	1111	0111	7
7	3223	3123	19	3200	0213	11	1110	0011	5
8	1222	2443	20	3111	1133	14	0013	4331	15
9	3221	1122	14	2000	2123	10	3533	3434	28
10	2111	1212	11	0223	4544	24	3223	3444	25
11	2011	0020	6	3323	3333	23	2232	4432	22
12	0001	2322	10	2222	3333	20	3332	3243	23
13	3111	2342	17	1131	4331	17	2223	3222	18
14	3224	3453	26	2122	3143	18	3322	2434	23
15	2222	3222	17	2223	3332	20	4223	3222	20
16	2233	2333	21	2222	2130	14	2111	2222	13
17	2212	3124	17	0112	2112	10	2111	1321	12
18	3332	2332	21	1012	4434	19	3311	2111	13
19	1123	2422	17	3232	3332	21	0121	3333	16
20	1221	2032	13	1311	1201	10	2112	3333	18
21	1112	1223	13	1112	2331	14	2111	0233	13
22	1110	0110	5	1011	1011	6	2001	2123	11
23	0012	1133	11	0112	1232	12	3322	2222	18
24	0111	2232	12	1011	1222	10	1111	1110	7
25	3322	1042	17	2011	0100	5	0012	2113	10
26	3121	1213	14	0111	1122	9	1133	4454	25
27	1101	1132	10	1111	2352	16	4433	3555	32
28	0111	0023	8	3323	2545	27	4343	4443	29
29	1211	1000	6	4233	3644	29	2211	2234	17
30	1100	0000	2				3212	2213	16
31	0001	2333	12				1101	2021	8

Three-hour-range K indices**Hel, April - June, 2008****The limit of K=9 is 550**

Day	April			May			June		
	K	SK		K	SK		K	SK	
1	1211	1110	8	1112	1234	15	2222	2321	16
2	0000	0001	1	5212	3101	15	2212	3221	15
3	2001	0100	4	3233	4232	22	1102	2322	13
4	0011	2443	15	1223	2333	19	2121	2101	10
5	2123	3534	23	2131	3432	19	1002	1210	7
6	3443	3233	25	3222	2121	15	1223	2222	16
7	3322	1433	21	2001	2222	11	2133	3233	20
8	2213	4233	20	2112	2111	11	3212	4312	18
9	2233	3233	21	1111	2111	9	1001	1011	5
10	3222	3233	20	1111	1122	10	1001	2110	6
11	3112	2201	12	2111	2121	11	1122	1001	8
12	3223	3133	20	1010	1211	7	1221	1111	10
13	1112	3421	15	1101	1220	8	1100	1120	6
14	1100	0000	2	0102	2110	7	1001	2445	17
15	0001	3223	11	0111	1111	7	3433	3324	25
16	2223	4343	23	1202	2221	12	2223	3334	22
17	3212	2221	15	1001	0100	3	2223	3322	19
18	2222	2212	15	0002	3111	8	3322	3211	17
19	2111	1223	13	2113	3321	16	1112	3222	14
20	2111	1221	11	2122	3333	19	2333	2222	19
21	1101	1211	8	3323	3222	20	1111	2211	10
22	0002	1323	11	2222	3432	20	2111	2111	10
23	3343	3433	26	2102	2233	15	2101	1000	5
24	3333	3223	22	3122	2312	16	1000	1123	8
25	2222	3221	16	2211	2211	12	3221	2333	19
26	3122	2433	20	1111	0111	7	3333	4322	23
27	2112	2321	14	0011	1112	7	3223	3321	19
28	1122	3443	20	3222	4323	21	1112	2222	13
29	2211	1121	11	2212	3332	18	2212	2223	16
30	0111	1351	13	3112	3442	20	1102	2220	10
31				0223	3332	18			

Three-hour-range K indices
Hel, July - September, 2008
The limit of K=9 is 550

Day	July			August			September		
	K		SK	K		SK	K		SK
1	2112	3101	11	1010	2222	10	1000	2111	6
2	2001	1010	5	0001	1111	5	1112	1111	9
3	1001	2211	8	1011	2122	10	1223	2333	19
4	0001	2211	7	1011	1111	7	5533	3433	29
5	1223	3322	18	0001	1100	3	2212	2122	14
6	1111	1110	7	11-12	2222	-1	3222	3233	20
7	1111	0101	6	1111	1222	11	3122	3241	18
8	0001	1111	5	0000	1212	6	1232	2343	20
9	0111	1111	7	3323	3445	27	1211	1113	11
10	0002	2212	9	3332	2322	20	1111	1121	9
11	1122	3223	16	2212	3211	14	0000	1112	5
12	3433	4232	24	1232	2312	16	1000	0000	1
13	2233	3432	22	2112	1111	10	0000	0001	1
14	2223	3422	20	2211	2210	11	0011	1143	11
15	3222	2222	17	2111	1100	7	3233	3433	24
16	1111	2212	11	0111	1123	10	1222	1432	17
17	2211	1210	10	3112	3212	15	3101	1001	7
18	0101	1101	5	2224	4443	25	2212	1111	11
19	0001	1101	4	3222	3331	19	0111	1131	9
20	1001	1121	7	2112	2100	9	1100	1100	4
21	2111	2222	13	1001	2011	6	0000	0112	4
22	0123	4333	19	1110	1001	5	3100	0101	6
23	3322	4333	23	1001	2111	7	2011	1011	7
24	3222	2222	17	0001	1001	3	1002	1100	5
25	1112	1101	8	1000	1001	3	1001	0133	9
26	2112	2221	13	0001	1110	4	1101	1100	5
27	0012	2124	12	2111	1000	6	0000	1222	7
28	2222	1211	13	0001	1111	5	0012	2100	6
29	0101	1212	8	1111	0211	8	0111	1001	5
30	1212	1112	11	0111	1000	4	0011	2223	11
31	0111	2211	9	0012	3121	10			

Three-hour-range K indices
Hel, October - December, 2008
The limit of K=9 is 550

Day	October			November			December		
	K	SK		K	SK		K	SK	
1	2222	2323	18	1010	0021	5	0000	0000	0
2	2223	4333	22	0011	1012	6	0000	0000	0
3	2232	3333	21	0000	0000	0	1111	1122	10
4	2323	2212	17	1000	0000	1	2322	3311	17
5	2211	1002	9	0000	0000	0	2112	2525	20
6	1111	0101	6	0000	0010	1	3322	2432	21
7	0000	1120	4	0112	2224	14	2122	2312	15
8	1100	0001	3	3223	3232	20	1100	1221	8
9	0010	0000	1	4222	1233	19	0000	0100	1
10	0002	1103	7	1111	0210	7	0001	1222	8
11	2133	5653	28	0101	0000	2	2211	1211	11
12	4322	2323	21	1010	0112	6	1001	1111	6
13	3122	1232	16	0000	0000	0	1101	0010	4
14	1011	1121	8	0000	0111	3	1000	0000	1
15	3222	1122	15	1100	0123	8	0110	0112	6
16	1011	0011	5	3222	1023	15	0011	2133	11
17	0000	1000	1	1120	0011	6	3210	1210	10
18	0000	0010	1	0000	0010	1	0000	1121	5
19	1112	2332	15	0000	0010	1	1001	1211	7
20	1000	1112	6	0100	0021	4	1000	1100	3
21	2111	1012	9	0001	0000	1	0111	0000	3
22	0001	1232	9	0000	0010	1	0000	0332	8
23	11-1-1-1110	-1	-1	2110	0010	5	2222	1344	20
24	011-11000	-1	-1	0000	0003	3	2122	2232	16
25	0001	0111	4	4332	3232	22	1001	2131	9
26	0221	1201	9	3322	2233	20	1000	0022	5
27	1001	0000	2	2112	1233	15	1000	1011	4
28	0122	1221	11	1111	0123	10	1011	0111	6
29	2332	3443	24	0111	0112	7	0001	0000	1
30	3223	2532	22	1000	0210	4	0000	0011	2
31	2221	1232	15				3323	2232	20

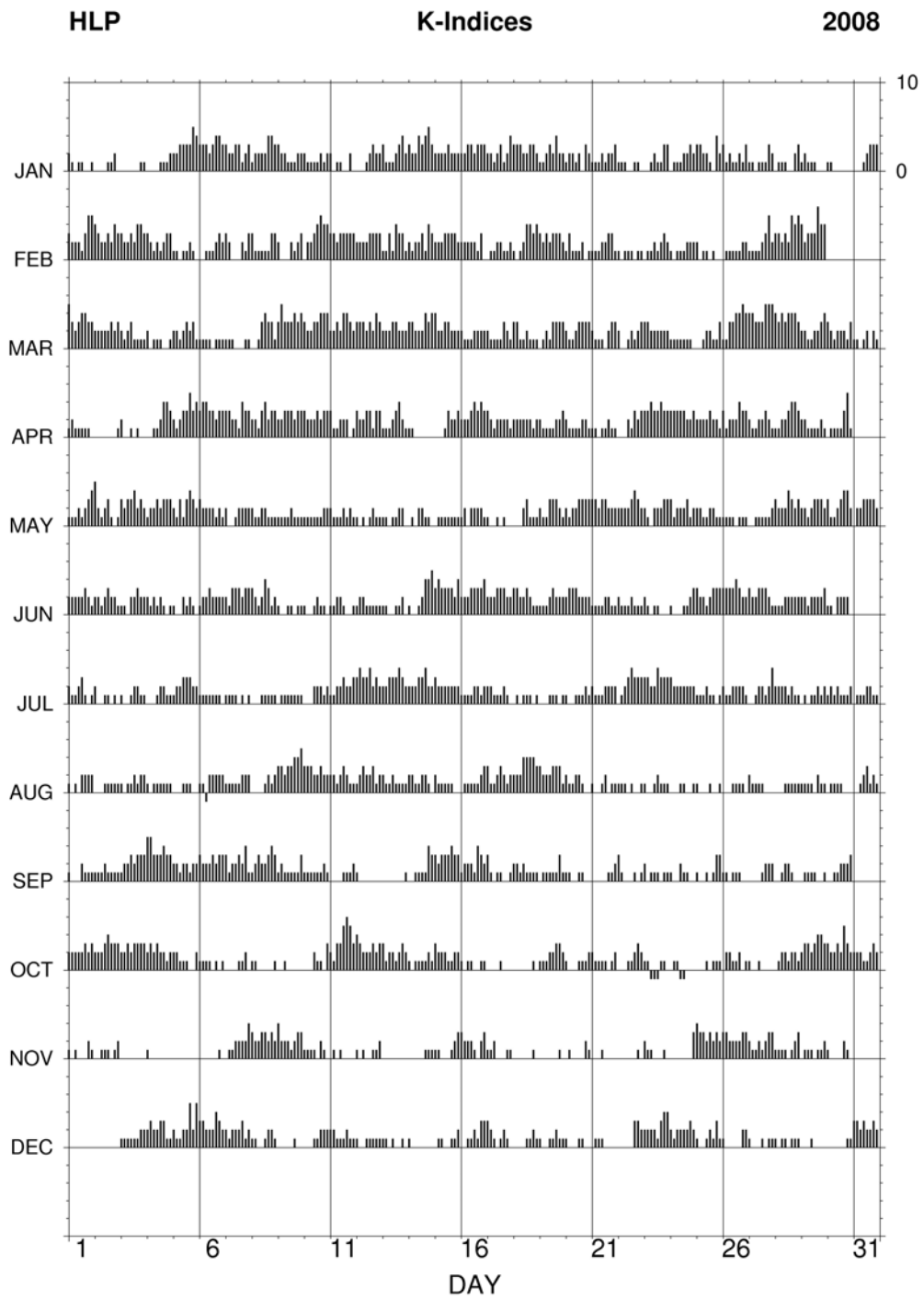

Fig. 20. K-indices in graphical form, Hel 2008.

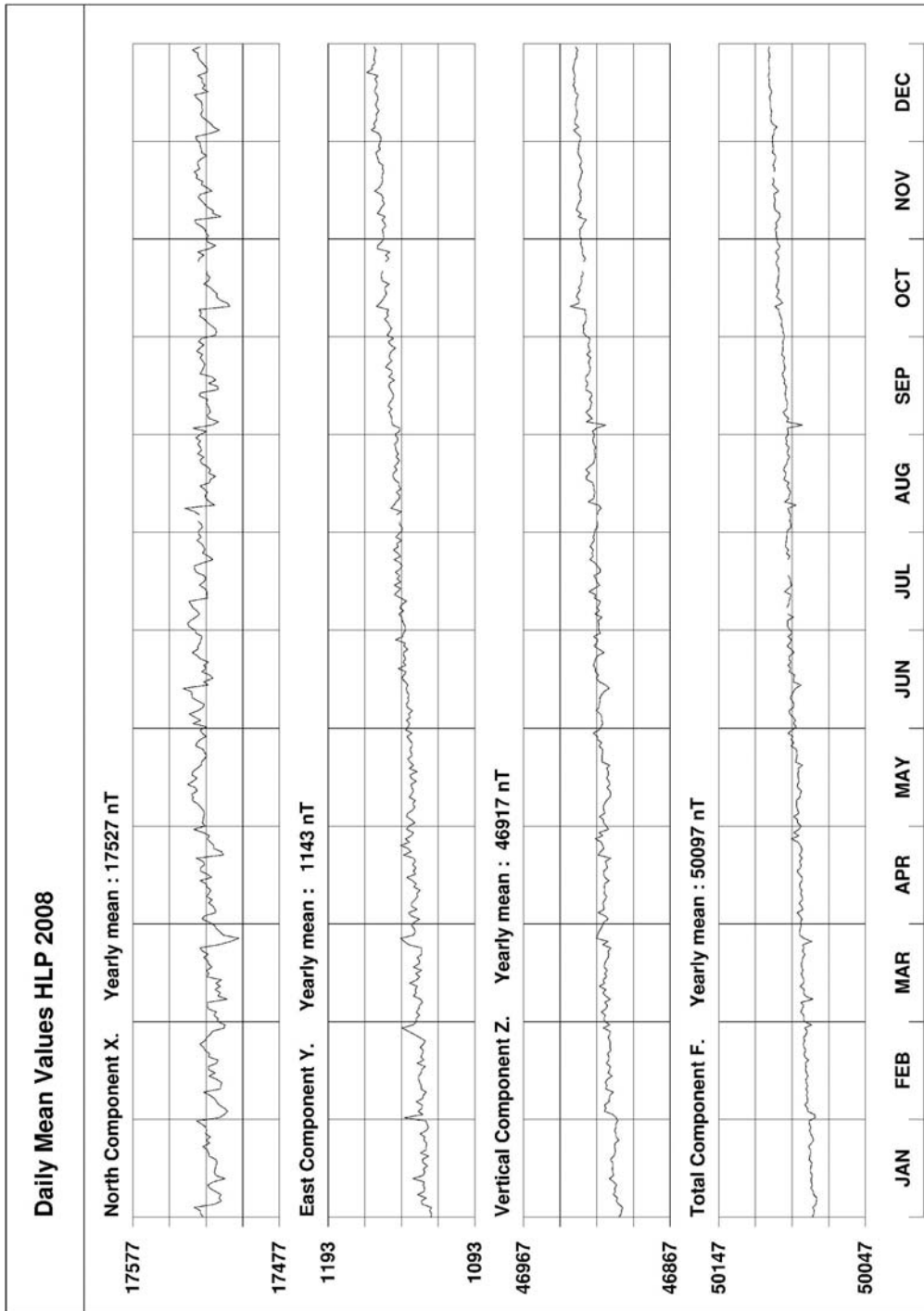

Fig. 21. Daily mean data plot for Hel 2008.

HLP - Hourly Mean Values

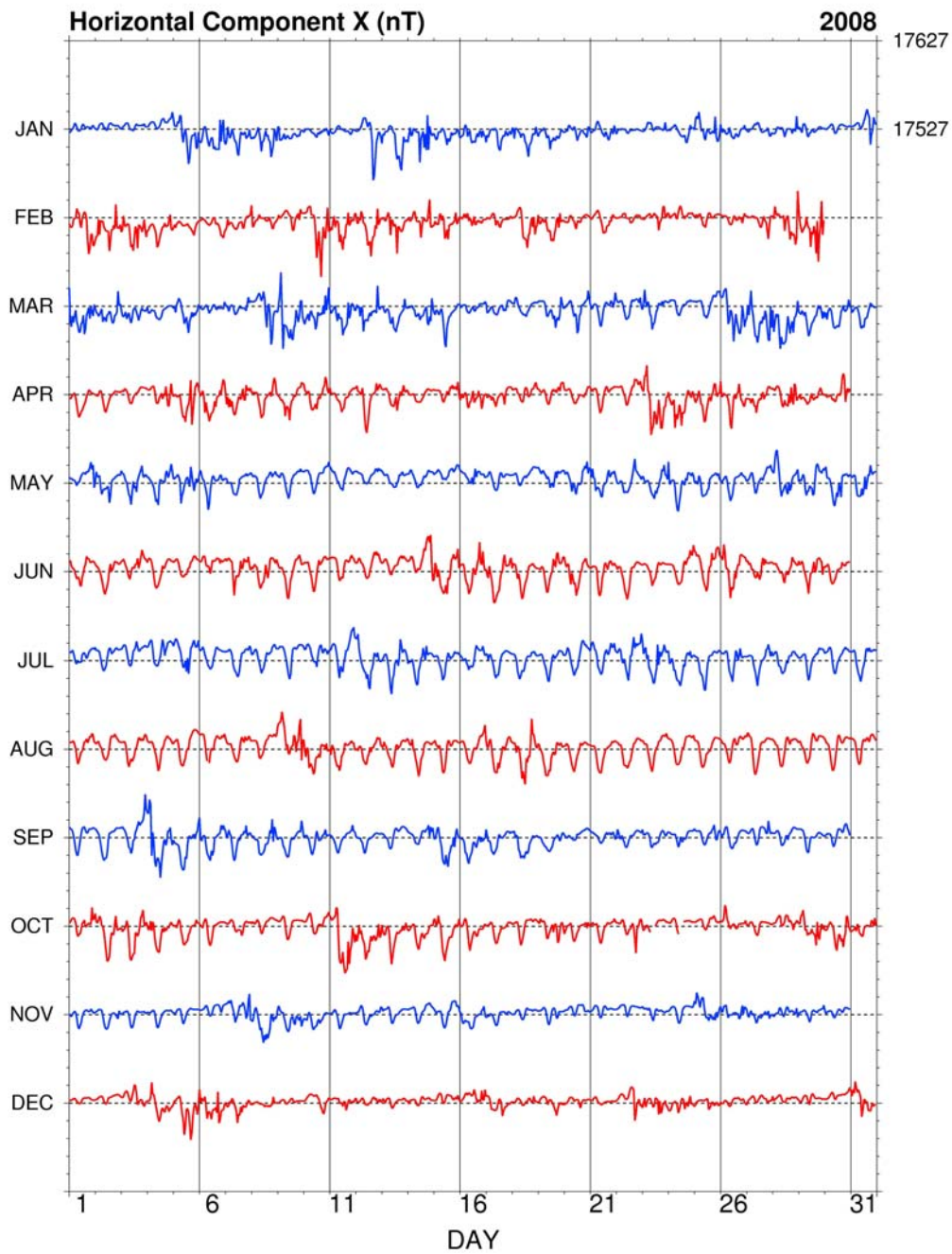

Fig. 22. Hourly mean data plot of X component for Hel 2008.

HLP - Hourly Mean Values

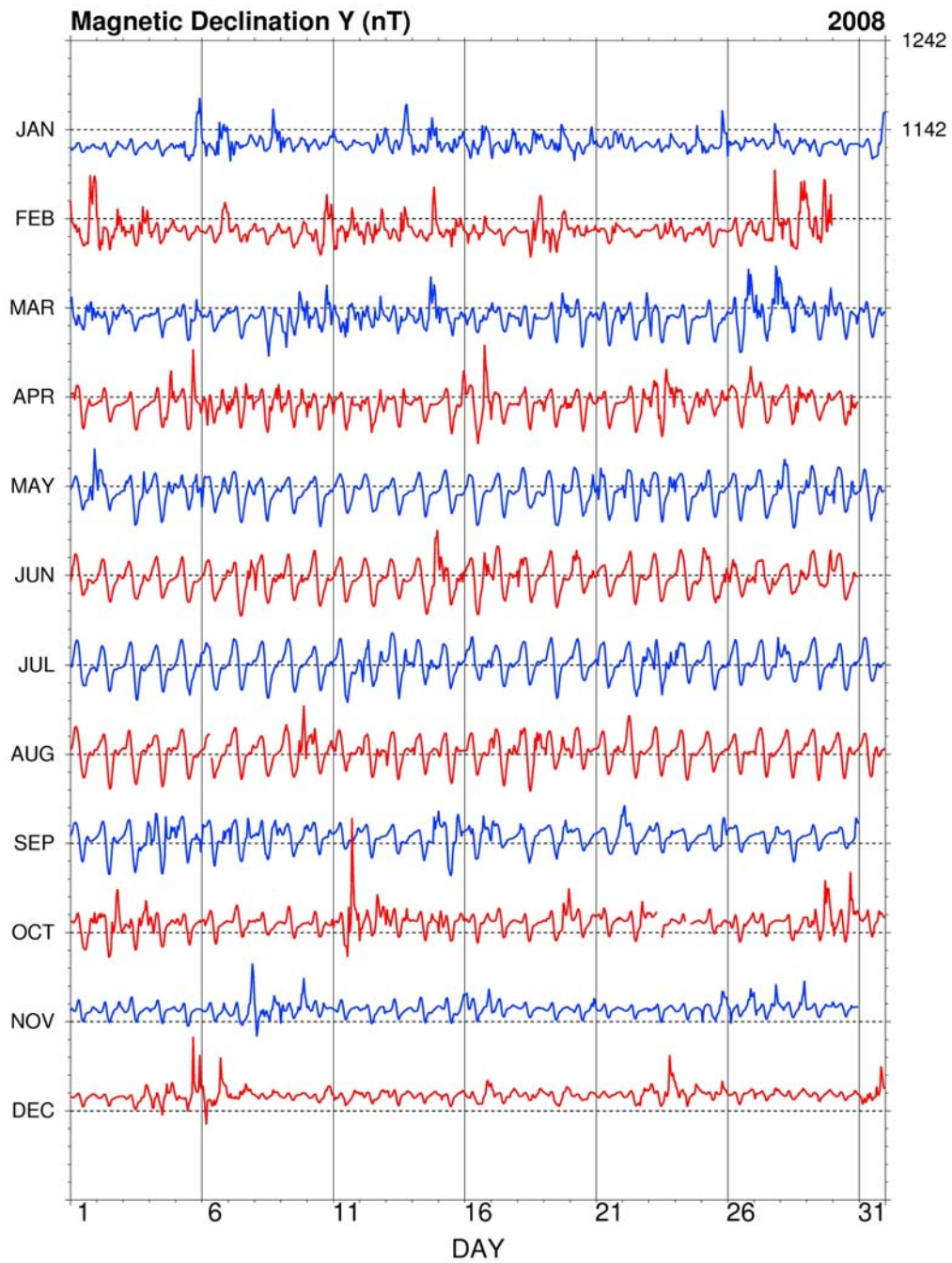

Fig. 23. Hourly mean data plot of Y component for Hel 2008.

HLP - Hourly Mean Values

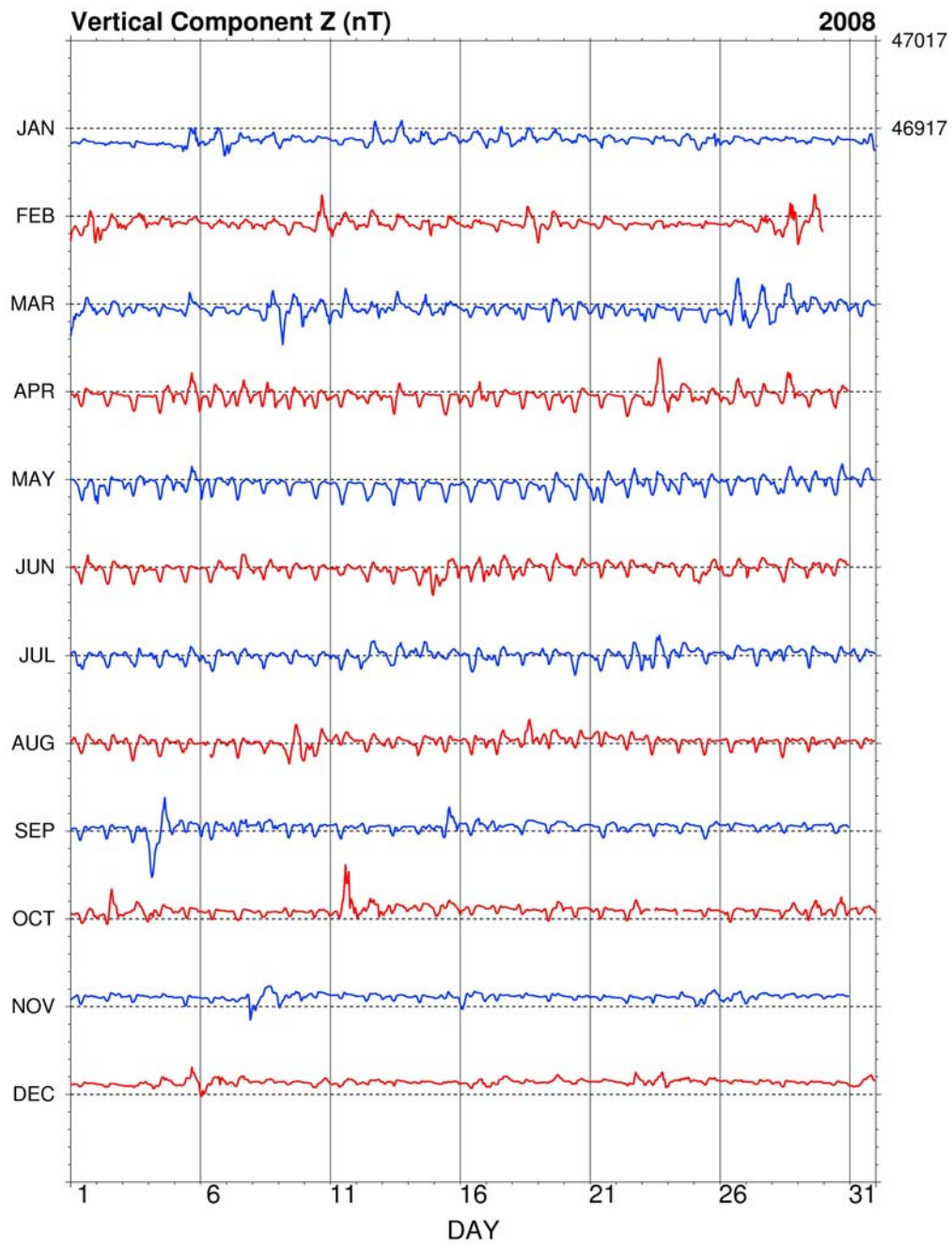

Fig. 24. Hourly mean data plot of Z component for Hel 2008.

HLP - Hourly Mean Values

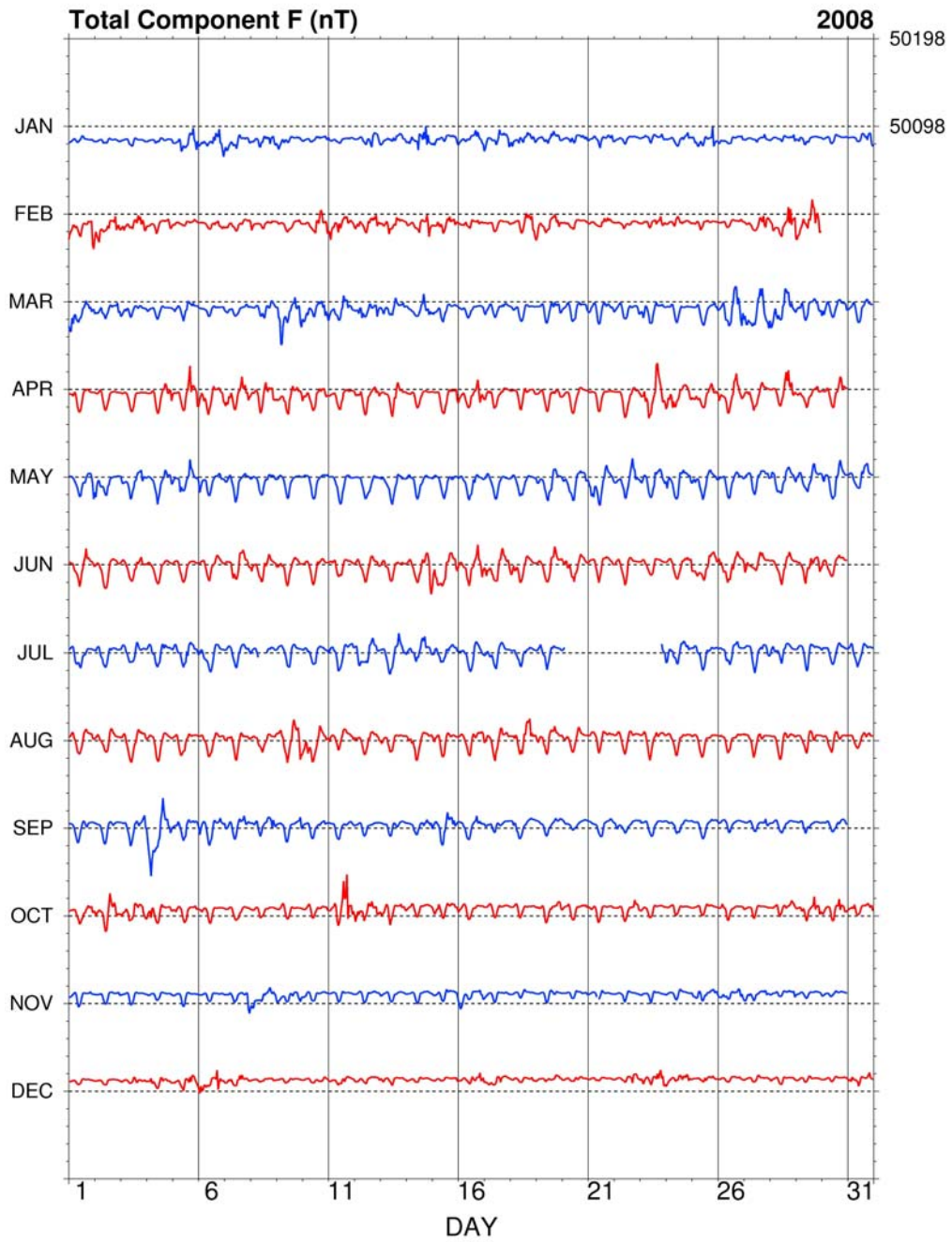

Fig. 25. Hourly mean data plot of F component for Hel 2008.

Tables and plots for Hornsund Observatory

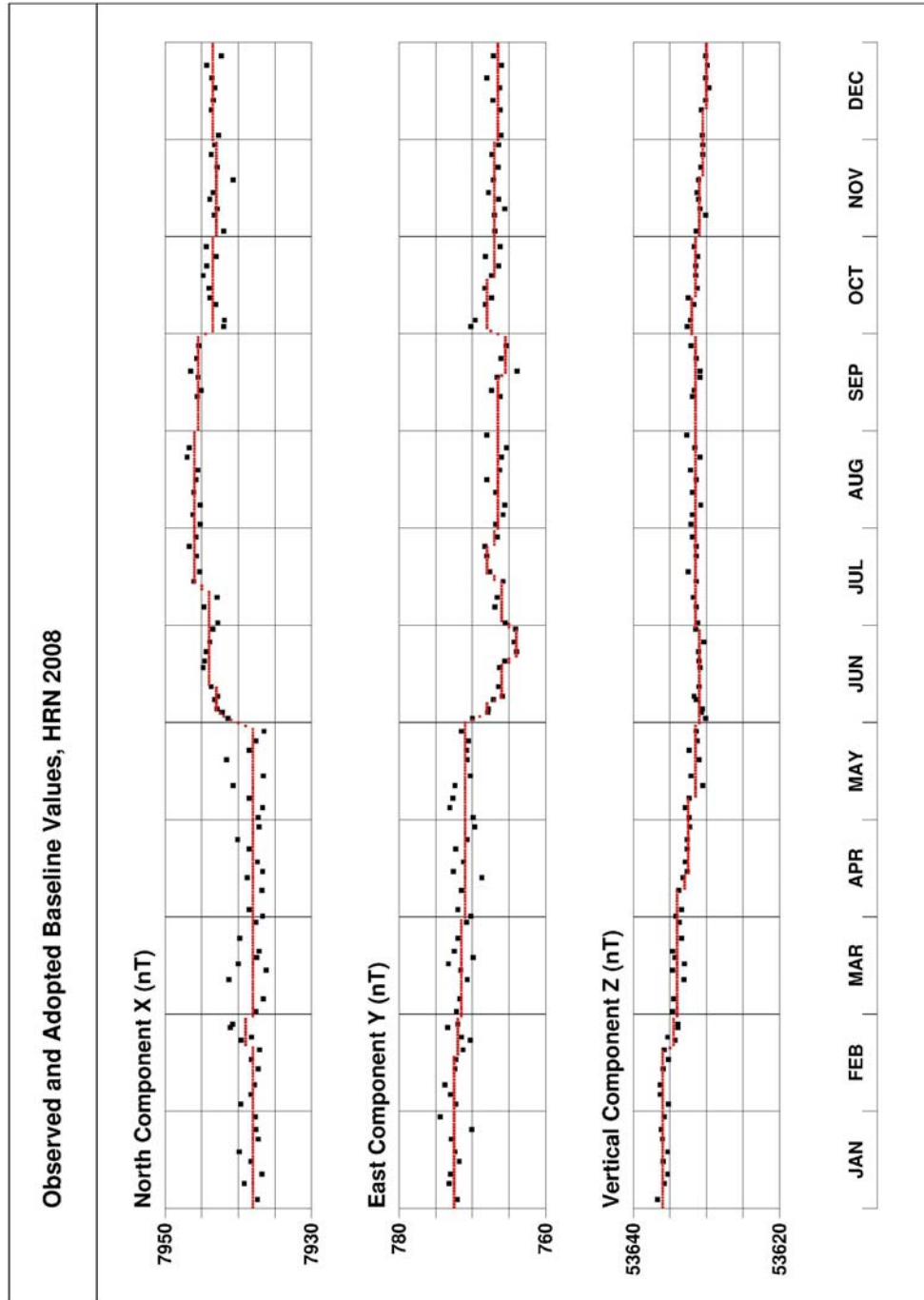

Fig. 26. Base values, Hornsund 2008.

Annual mean values of magnetic elements in Hornsund Observatory

Year	D [° ´]	H [nT]	Z [nT]	X [nT]	Y [nT]	I [° ´]	F [nT]
1979	-0 32.2	8384	53447	8384	-79	81 05.1	54101
1980	-0 14.2	8370	53447	8370	-35	81 06.0	54098
1981	-0 09.3	8351	53449	8351	-23	81 07.2	54097
1982	-0 09.4	8319	53481	8319	-23	81 09.5	54124
1983	-0 02.0	8295	53457	8295	-5	81 10.8	54097
1984	0 07.7	8266	53439	8266	19	81 12.4	54075
1985	0 14.3	8238	53405	8238	34	81 13.9	54037
1986	0 20.4	8213	53392	8213	49	81 15.3	54020
1987	0 25.6	8193	53360	8193	61	81 16.3	53985
1988	0 34.7	8168	53368	8168	82	81 17.9	53989
1989	0 40.8	8148	53369	8147	97	81 19.2	53987
1990	0 47.2	8122	53360	8121	112	81 20.7	53975
1991	0 53.0	8107	53355	8106	125	81 21.6	53967
1992	1 01.4	8088	53352	8087	144	81 22.8	53962
1993	1 12.9	8065	53356	8063	171	81 24.3	53962
1994	1 25.9	8044	53374	8041	201	81 25.8	53977
1995	1 38.4	8038	53374	8035	230	81 26.1	53976
1996	1 51.4	8023	53385	8019	260	81 27.2	53985
1997	2 07.2	8004	53406	7999	296	81 28.6	54003
1998	2 24.0	8001	53440	7994	335	81 29.1	54036
1999	2 39.1	7998	53471	7989	370	81 29.6	54066
2000	2 55.5	7996	53504	7986	408	81 30.0	54098
2001	3 12.4	7992	53542	7979	447	81 30.6	54135
2002	3 29.7	7989	53585	7974	487	81 31.2	54177
2003	3 49.8	7965	53646	7947	532	81 33.3	54234
2004	4 04.2	7961	53675	7941	565	81 33.8	54262
2005	4 20.5	7953	53707	7930	602	81 34.6	54293
2006	4 36.2	7958	53727	7932	639	81 34.5	54314
2007	4 51.3	7950	53757	7922	673	81 35.2	54342
2008	5 07.9	7941	53785	7909	710	81 36.1	54368

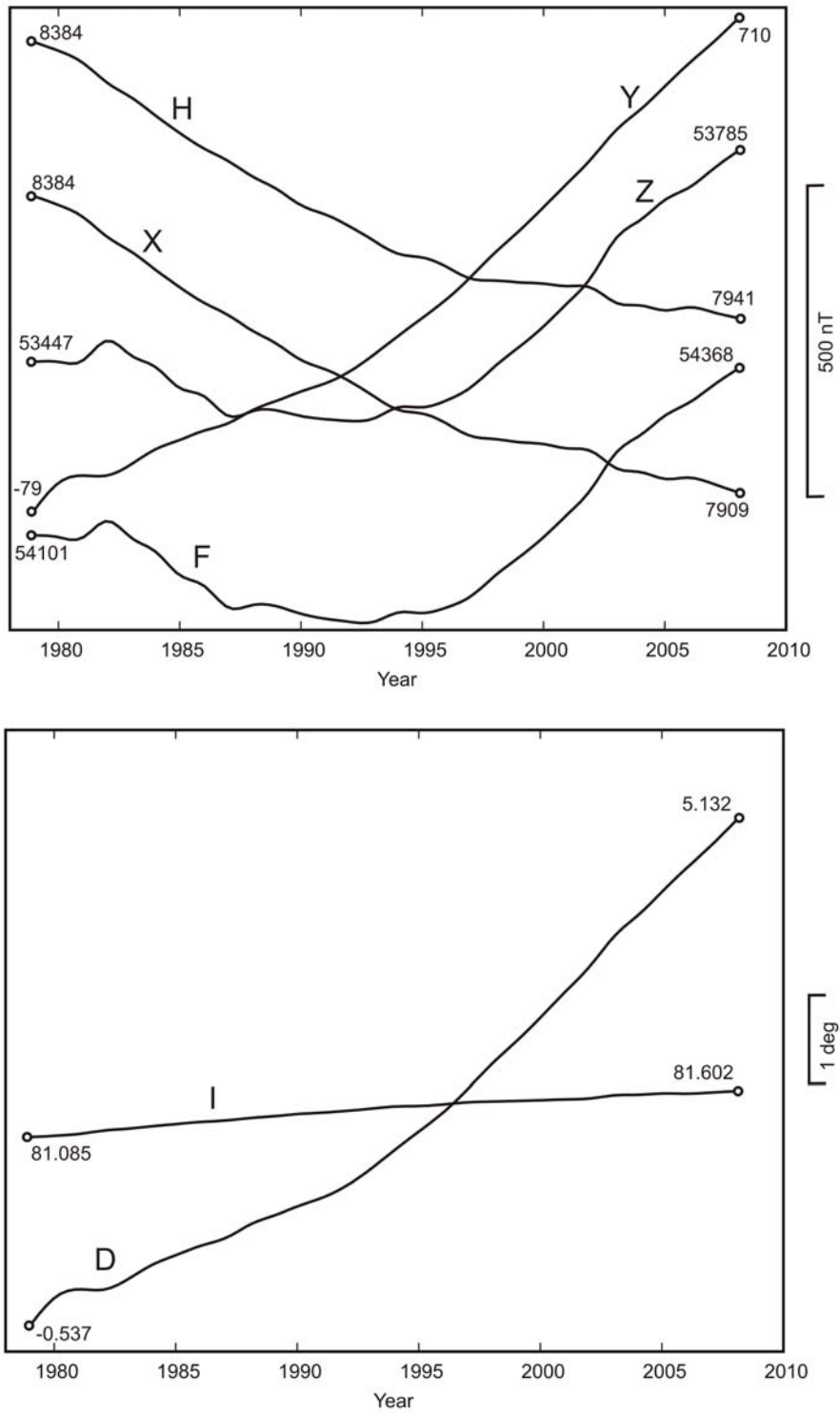

Fig. 27. Secular changes of H, X, Y, Z, F, D and I at Hornsund.

MONTHLY AND YEARLY MEAN VALUES OF MAGNETIC ELEMENTS

Hornsund

2008

JAN FEB MAR APR MAY JUN JUL AUG SEP OCT NOV DEC MEAN

NORTH COMPONENT: 7500 + ... in nT

All days	398	396	398	410	424	425	424	417	409	402	403	398	409
Quiet days	414	418	416	417	425	428	421	419	411	411	409	408	416
Disturbed days	372	369	352	388	424	418	417	413	389	370	386	368	389

EAST COMPONENT: 500 + ... in nT

All days	196	197	202	201	200	204	210	213	219	223	228	230	210
Quiet days	192	194	198	200	200	205	209	213	217	222	225	228	209
Disturbed days	202	196	218	213	197	202	214	215	222	227	236	237	215

VERTICAL COMPONENT: 53500 + ... in nT

All days	279	282	290	286	277	283	275	281	292	293	294	293	285
Quiet days	269	271	281	285	274	276	284	278	282	287	286	289	280
Disturbed days	282	303	307	292	280	288	269	287	305	302	309	301	294

Three-hour-range K indices
Hornsund, January - March, 2008
The limit of K=9 is 2500

Day	January			February			March		
	K	SK		K	SK		K	SK	
1	1221	2101	10	4333	1245	25	6554	3454	36
2	1210	0022	8	2442	3375	30	3343	3235	26
3	0101	0034	9	5443	2435	30	4333	2133	22
4	0001	0033	7	3343	2256	28	3132	2000	11
5	1233	3255	24	3312	2122	16	1333	4322	21
6	2442	3465	30	1222	1353	19	1232	1112	13
7	4443	3223	25	3211	1214	15	3121	1011	10
8	2343	2555	29	4222	3024	19	0012	4211	11
9	4333	1132	20	1111	2122	11	4533	3655	34
10	2222	1115	16	1223	4355	25	3453	3345	30
11	5222	1030	15	2443	3643	29	4343	4634	31
12	0023	1212	11	2453	3264	29	2453	3265	30
13	2322	2344	22	1343	3552	26	1454	4324	27
14	3464	3464	34	2343	3165	27	2443	3644	30
15	2443	3224	24	2444	4553	31	3354	3221	23
16	2464	3655	35	1443	2252	23	2422	3312	19
17	3333	3244	25	0143	2103	14	3311	2332	18
18	3553	3333	28	1233	3355	25	2322	3111	15
19	2353	3542	27	3243	3354	27	0332	3565	27
20	1443	2154	24	1333	2200	14	2223	3121	16
21	2233	2444	24	1233	3432	21	2222	1052	16
22	3222	2120	14	0122	2100	8	1212	2113	13
23	0122	3045	17	0232	2253	19	3433	2112	19
24	1322	2323	18	1123	1222	14	1312	1110	10
25	2442	1063	22	1223	1100	10	0112	2112	10
26	3243	2213	20	0222	1113	12	2234	3435	26
27	1311	1253	17	1321	3452	21	4644	3355	34
28	1222	1034	15	4433	3556	33	4444	5445	34
29	1223	2001	11	6344	3736	36	3333	4345	28
30	1111	1000	5				3333	3233	23
31	0000	0124	7				2212	2252	18

Three-hour-range K indices
Hornsund, April - June, 2008
The limit of K=9 is 2500

Day	April			May			June		
	K	SK		K	SK		K	SK	
1	2322	1210	13	2232	2225	20	3332	2522	22
2	0110	0020	4	4332	3101	17	2313	2233	19
3	1001	2100	5	3224	4242	23	2222	2144	19
4	0221	3445	21	2333	3544	27	2222	2111	13
5	2233	3733	26	3342	3632	26	2112	1121	11
6	3443	3252	26	5333	3143	25	1322	3223	18
7	2443	2653	29	2222	2143	18	3244	4354	29
8	2233	4334	24	2343	1231	19	2323	3343	23
9	2344	3153	25	2222	3001	12	3212	2032	15
10	2343	3255	27	1331	2021	13	1111	2120	9
11	2322	3321	18	2231	1032	14	1121	1101	8
12	2344	3153	25	1121	1231	12	1331	1103	13
13	2233	3541	23	1311	1111	10	1220	1010	7
14	1212	0100	7	1122	2132	14	1112	2336	19
15	0102	2124	12	1210	2111	9	3543	4333	28
16	1234	3253	23	2313	2121	15	3343	2455	29
17	2223	3220	16	1001	1110	5	3444	3433	28
18	1343	3212	19	0111	2001	6	4433	3121	21
19	2232	2212	16	3222	3231	18	2222	2242	18
20	2211	2431	16	2322	3235	22	2343	3222	21
21	2222	1210	12	3333	3222	21	2212	3122	15
22	1112	1141	12	2433	3552	27	2222	2100	11
23	3454	4632	31	2112	4253	20	2221	2100	10
24	5455	4344	34	4343	3422	25	2211	1123	13
25	2433	3252	24	1322	3122	16	3331	3233	21
26	4433	3425	28	1222	1232	15	4444	4321	26
27	2222	2321	16	2112	2214	15	3333	3411	21
28	2223	5455	28	3443	3332	25	2222	2351	19
29	2342	2253	23	3233	3442	24	3322	2223	19
30	1212	2541	18	3323	4552	27	1222	3222	16
31				1345	3342	25			

Three-hour-range K indices
Hornsund, July - September, 2008
The limit of K=9 is 2500

Day	July			August			September		
	K	SK		K	SK		K	SK	
1	2233	2121	16	1221	2123	14	1120	2122	11
2	2212	2022	13	1011	2002	7	0111	2100	6
3	1111	2111	9	1111	1212	10	0333	2215	19
4	0101	2310	8	1111	1112	9	7753	3335	36
5	2233	3224	21	0121	2100	7	2323	2133	19
6	3222	2121	15	1122	2132	14	4322	3212	19
7	1221	0003	9	2211	1113	12	3333	3252	24
8	1001	1112	7	1211	1111	9	2343	2553	27
9	1111	2111	9	2433	2436	27	2433	2003	17
10	1113	2222	14	2343	3334	25	2221	1143	16
11	3222	3212	17	2333	3221	19	1210	0123	10
12	3545	3333	29	2343	3212	20	3110	1000	6
13	2333	3543	26	2322	2132	17	0010	0000	1
14	2344	3533	27	2311	2201	12	0112	1134	13
15	2333	3122	19	3212	1110	11	2344	4353	28
16	2332	1234	20	0123	2122	13	1333	2653	26
17	3322	1220	15	3212	2212	15	3311	0011	10
18	2322	2211	15	2335	4354	29	1232	3243	20
19	1101	1003	7	3333	3431	23	0121	2122	11
20	1111	2022	10	2323	2210	15	0221	1100	7
21	2223	3221	17	1122	2221	13	0001	1001	3
22	1233	4244	23	2111	1111	9	3311	1000	9
23	4443	5432	29	2220	2003	11	2212	2101	11
24	4332	3244	25	1002	1002	6	1212	2100	9
25	2322	2013	15	1011	1001	5	0001	1023	7
26	2222	2231	16	0001	2011	5	1311	2000	8
27	1112	2133	14	1311	2010	9	0020	1022	7
28	2333	2211	17	1102	1112	9	1122	2000	8
29	1221	1113	12	1221	1110	9	0222	2003	11
30	2322	1121	14	0222	0000	6	0120	2203	10
31	1112	2111	10	0011	3123	11			

Three-hour-range K indices
Hornsund, October - December, 2008
The limit of K=9 is 2500

Day	October			November			December		
	K	SK		K	SK		K	SK	
1	2223	3212	17	1222	0011	9	0100	0000	1
2	3333	3253	25	0121	2111	9	0000	0000	0
3	2344	3345	28	0212	0001	6	0101	2114	10
4	3443	2212	21	1100	0003	5	1533	2223	21
5	2422	2012	15	0000	0000	0	2322	2324	20
6	0222	1000	7	0000	0011	2	5433	3763	34
7	0111	1132	10	0222	2125	16	2343	3423	24
8	1100	0000	2	2434	3143	24	2221	1233	16
9	0020	1000	3	4323	3244	25	1101	0000	3
10	0111	1002	6	2222	1220	13	0110	1133	10
11	1243	4653	28	0201	0010	4	2212	1220	12
12	3332	3654	29	1111	1011	7	1111	2122	11
13	2233	2152	20	1000	0000	1	3111	1023	12
14	2222	2231	16	0110	0000	2	1101	2002	7
15	2222	2414	19	0210	0001	4	0220	0012	7
16	3221	1121	13	3332	1025	19	1112	2154	17
17	0011	1120	6	2241	1033	16	3311	2323	18
18	0000	0010	1	1100	0000	2	0100	0043	8
19	1112	2232	14	0010	0120	4	0111	2211	9
20	1120	1112	9	1200	0032	8	0011	1100	4
21	2221	1102	11	1110	0000	3	0112	0110	6
22	0111	1232	11	0000	0000	0	0000	1321	7
23	2222	1000	9	0121	0011	6	3233	2266	27
24	0310	1000	5	0000	0000	0	3432	2143	22
25	0100	0001	2	3333	2255	26	1112	2143	15
26	0331	1101	10	4533	2155	28	2211	1014	12
27	3111	0000	6	4333	2254	26	2012	2010	8
28	0123	1112	11	2222	2045	19	1020	1113	9
29	3442	2663	30	1231	1113	13	0100	0003	4
30	2433	3634	28	3112	0100	8	0100	0011	3
31	2233	1143	19				1333	2254	23

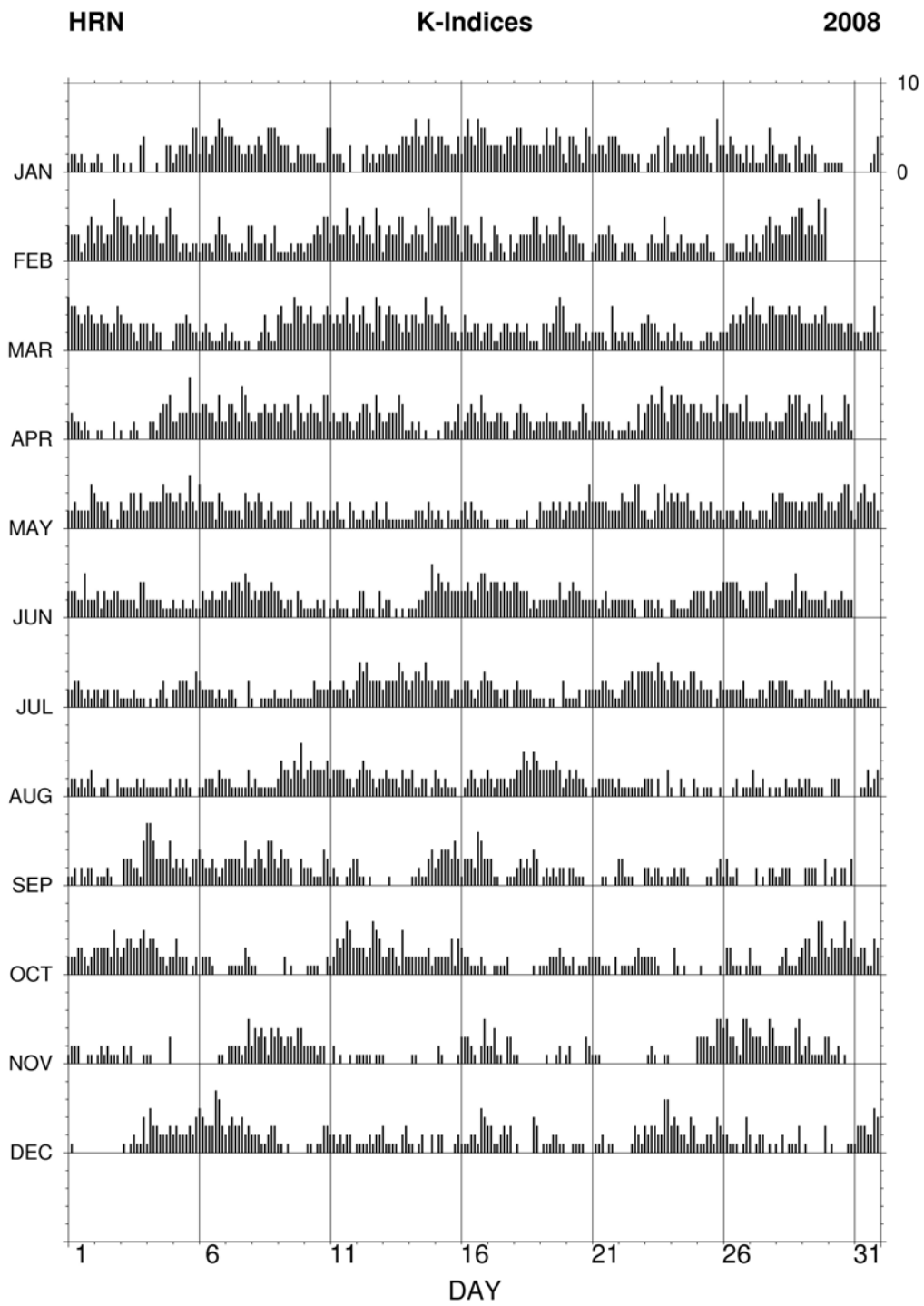

Fig. 28. K-indices in graphical form, Hornsund 2008.

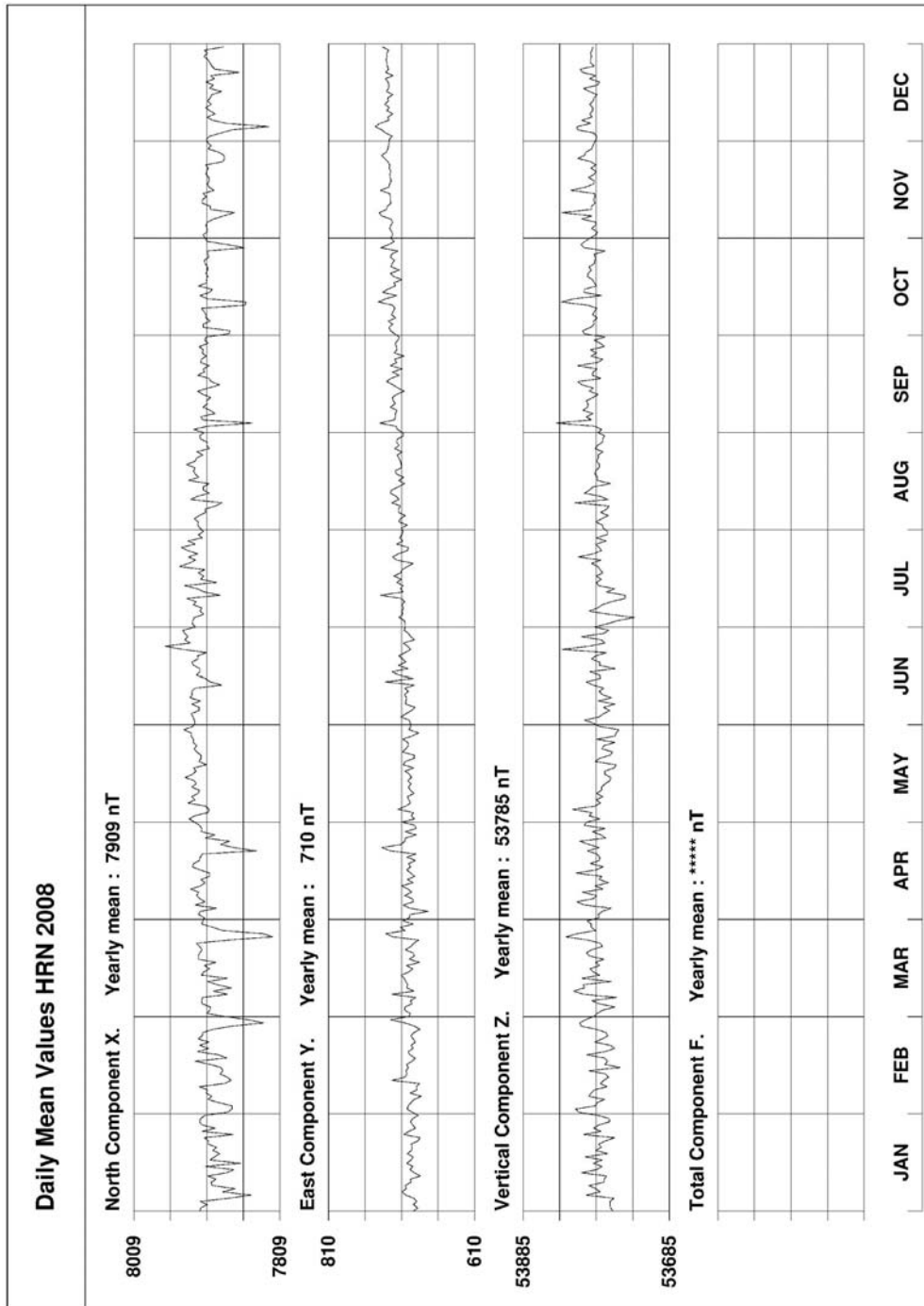

Fig. 29. Daily mean data plot for Hornsund 2008.

HRN - Hourly Mean Values

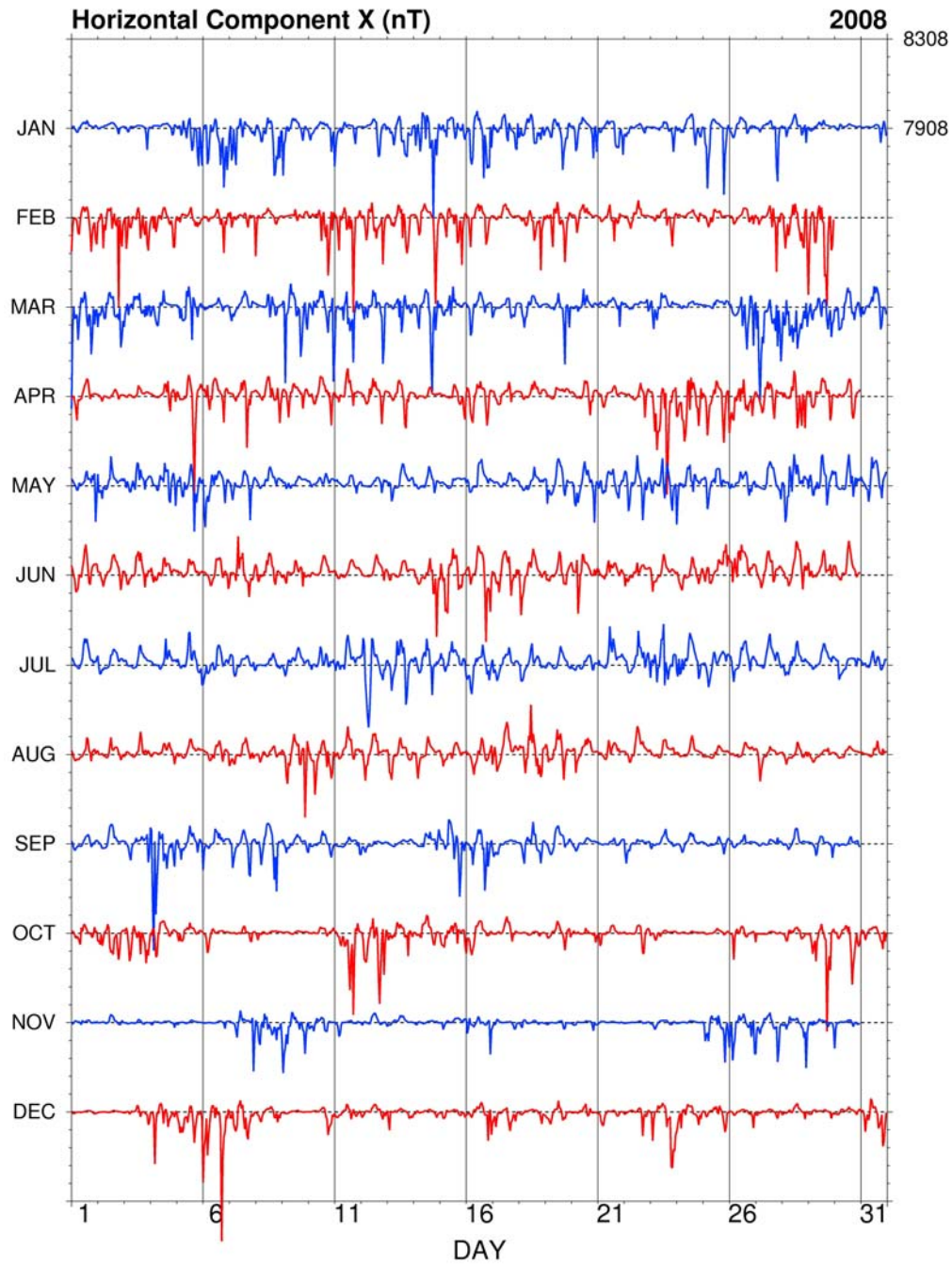

Fig. 30. Hourly mean data plot of X component for Hornsund.

HRN - Hourly Mean Values

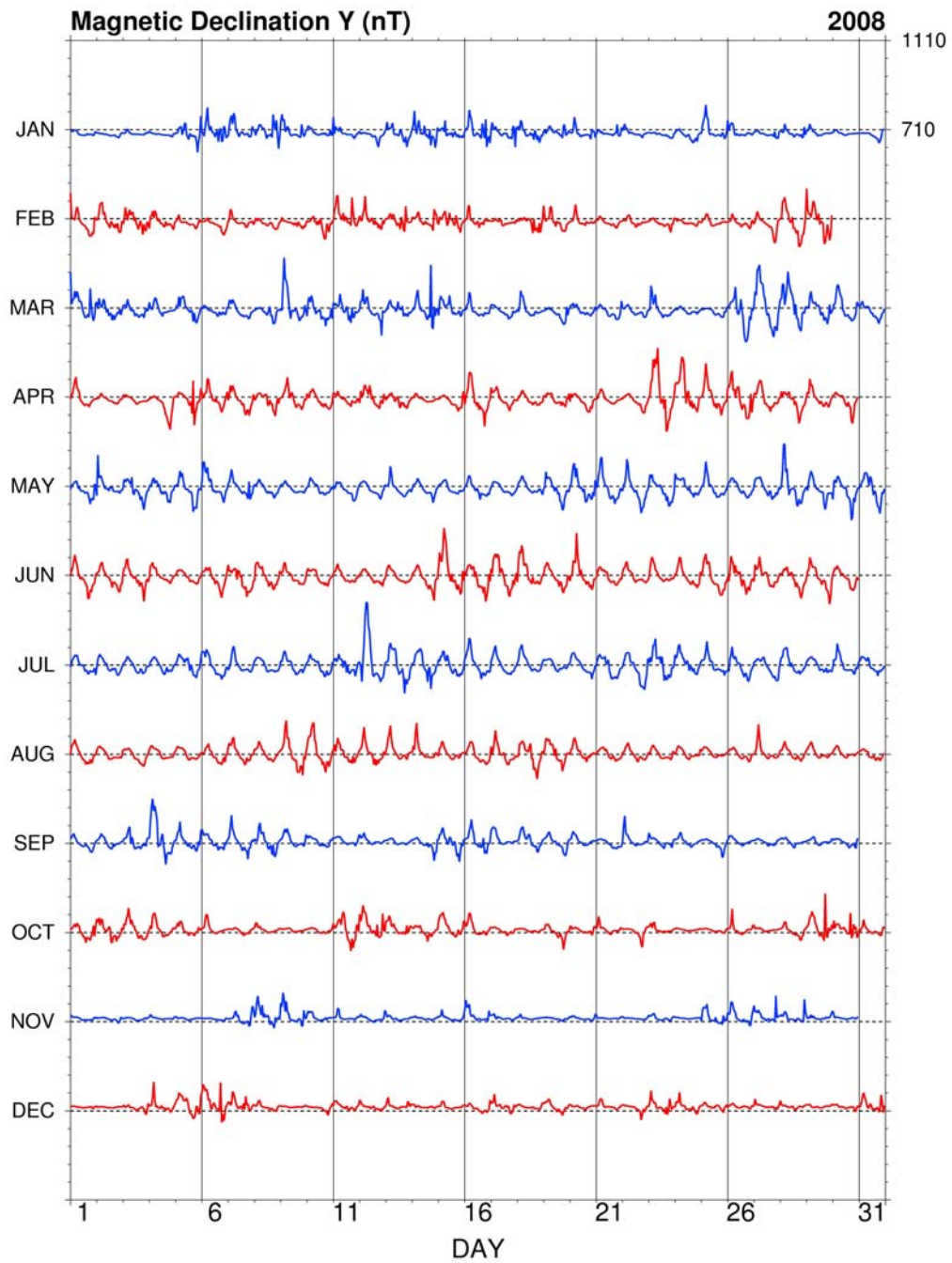

Fig. 31. Hourly mean data plot of Y component for Hornsund.

HRN - Hourly Mean Values

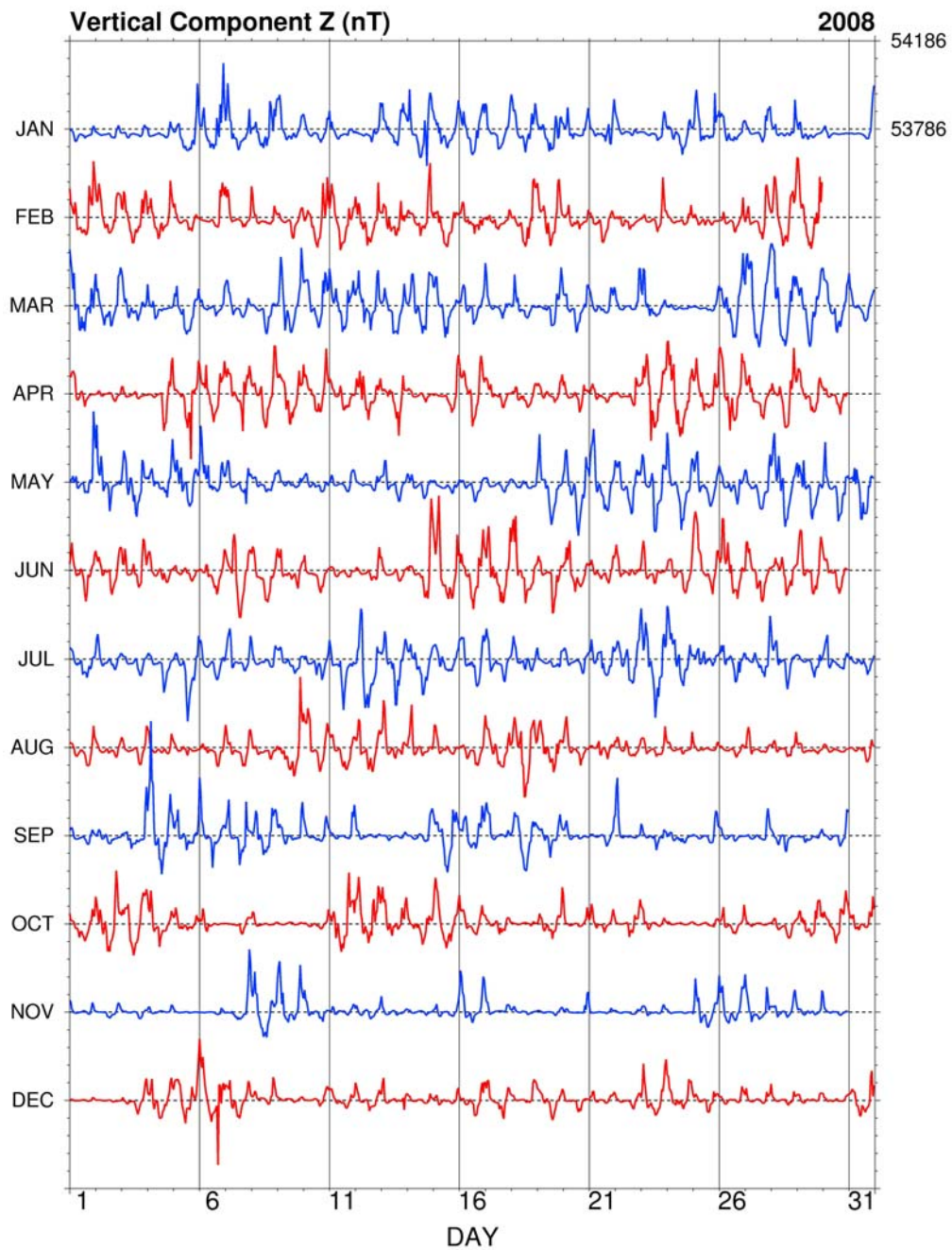

Fig. 32. Hourly mean data plot of Z component for Hornsund.

List of Yearbooks from Polish Geomagnetic Observatories

Below is the list of yearbooks with the results from the Polish geomagnetic observatories. Since the year 2006, one joint yearbook has been published in place of individual yearbooks from each observatory. The present edition is an activity report, and refers the reader to the internet where one-minute data are available. Most of the issues listed below are still available from the Institute of Geophysics.

I. Results of Geomagnetic Observations Belsk, Hel, Hornsund (since 2006)

Published in

Publications of the Institute of Geophysics, Pol. Acad. Sc.:

2006 – no C-100 (402)

2007 – no C-101 (408)

II. Results of Geomagnetic Observations, Belsk Geophysical Observatory (1966-2005)

Published in

Materiały i Prace Zakładu Geofizyki PAN:

1966 – no 20; 1967 – no 27; 1968 – no 42; 1969 – no 46;

1970 – no 50; 1971 – no 57; 1972 – no 70; 1973 – no 76;

1974 – no 88

Publications of the Institute of Geophysics, Pol. Acad. Sc.:

1975 – no C-2 (107); 1976 – no C-4 (114); 1977 – no C-5 (125);

1978 – no C-8 (133); 1979 – no C-9 (139); 1980 – no C-10- (144);

1981 – no C-13 (159); 1982 – no C-17 (166); 1983 – no C-20 (180);

1984 – no C-23 (187); 1985 – no C-26 (196); 1986 – no C-29 (205);

1987 – no C-34 (218); 1988 – no C-37 (227); 1989 – no C-38 (228);

1990 – no C-40 (240); 1991 – no C-45 (250); 1992 – no C-49 (259);
 1993 – no C-51 (267); 1994 – no C-55 (277); 1995 – no C-58 (287);
 1996 – no C-61 (296); 1997 – no C-68 (305); 1998 – no C-70 (312);
 1999 – no C-74 (318); 2000 – no C-79 (328); 2001 – no C-82 (343);
 2002 – no C-85 (356); 2003 – no C-89 (368); 2004 – no C-92 (379);
 2005 – no C-96 (392)

III. Results of Geomagnetic Observations, Hel Geophysical Observatory (1958-2005)

Published in

Publications of the Institute of Geophysics, Pol. Acad. Sc.:

1958-1965 – no C-41 (241); 1966-1970 – no C-6 (127);
 1971-1975 – no C-7 (128); 1976-1979 – no C-11 (154);
 1980-1981 – no C-16 (165) 1982 – no C-18 (170);
 1983 – no C-19 (179); 1984 – no C-24 (128); 1985 – no C-25 (195);
 1986 – no C-30 (206); 1987 – no C-33 (217); 1988 – no C-36 (226);
 1989 – no C-39 (239); 1990 – no C-42 (242); 1991 – no C-46 (251);
 1992 – no C-50 (260); 1993 – no C-52 (268); 1994 – no C-56 (278);
 1995 – no C-59 (288); 1996 – no C-62 (297); 1997 – no C-67 (304);
 1998 – no C-71 (313); 1999 – no C-76 (320); 2000 – no C-81 (330);
 2001 – no C-84 (345); 2002 – no C-87 (358); 2001 – no C-84 (345);
 2003 – no C-91 (370); 2004 – no C-94 (381); 2005 – no C-98 (394)

IV. Results of Geomagnetic Observations, Polish Polar Station Hornsund, Spitsbergen (1978-2005)

Published in

Publications of the Institute of Geophysics, Pol. Acad. Sc.:

1978-1979 – no C-14 (163); 1980-1981 – no C-27 (199);
 1982-1983 – no C-31 (210); 1984-1985 – no C-43 (243);

1986-1987 – no C-47 (254);	1988-1989 – no C-48 (256);	
1990-1991 – no C-53 (272);	1992-1993 – no C-57 (286);	
1994-1995 – no C-64 (301);	1996 – no C-66 (303);	
1997 – no C-69 (311);	1998 – no C-72 (315);	1999 – no C-75 (319);
2000 – no C-80 (329);	2001 – no C-83 (344);	2002 – no C-86 (357);
2003 – no C-90 (369);	2004 – no C-93 (380);	2005 – no C-97 (393)

V. Results of Geomagnetic Observations, Polish Antarctic Station Arctowski (1978-1995)

Published in

Publications of the Institute of Geophysics, Pol. Acad. Sc.:

1978-1979 – no C-21 (181);	1980-1981 – no C-22 (182);
1982-1983 – no C-28 (202);	1984-1985 – no C-32 (212);
1986-1987 – no C-35 (225);	1988-1989 – no C-44 (244);
1990-1991 – no C-54 (276);	1992-1993 – no C-60 (292);
1994-1995 – no C-63 (300)	

VI. Yearbooks from Świder Observatory (1937-1967)

Annales Magnetiques (Roczniki magnetyczne) for the years 1937-1967 were published in *Travaux de l'Observatoire Geophysique de St. Kalinowski a Swider (Prace Obserwatorium Geofizycznego im. St. Kalinowskiego w Świdrze)*.

CONTENTS

Results of Geomagnetic Observations Belsk, Hel, Hornsund, 2008	3
Tables and plots for Belsk Observatory	19
Tables and plots for Hel Observatory.....	39
Tables and plots for Hornsund Observatory.....	55
List of Yearbooks from Polish Geomagnetic Observatories	69