

Results of Geomagnetic Observations Belsk, Hel, Hornsund 2007

Jan REDA, Mariusz NESKA and Stanisław WÓJCIK

Institute of Geophysics, Polish Academy of Sciences
ul. Księcia Janusza 64, 01-452 Warszawa, Poland

1. INTRODUCTION

This publication contains basic information on geomagnetic observations carried out in 2007 in three Polish geophysical observatories: Belsk (BEL), Hel (HLP), and Hornsund (HRN). All these observatories belong to the Institute of Geophysics, Polish Academy of Sciences. Observatories Belsk and Hel are located on the territory of Poland, while Hornsund is in Spitsbergen archipelago, governed by Norway.

In 2007, like in the previous years, the Belsk, Hel and Hornsund observatories have kept a close collaboration with the world network of geomagnetic observatories INTERMAGNET. The Belsk Observatory joined INTERMAGNET in 1992, Hel in 1999, and Hornsund in 2002.

2. DESCRIPTION OF OBSERVATORIES

The location of observatories is shown in Fig. 1 and Table 1. The geomagnetic coordinates in Table 1 were calculated in relation to the geomagnetic pole located at 83.2°N , 118.3°W on the basis of model IGRF-10 from epoch 2005.

The methodology of geomagnetic observations in all the three observatories was very similar, based on the "Guide for Magnetic Measurements and Observatory Practice" (Jankowski and Sucksdorff 1996). The instruments were similar too. Absolute measurements were made with the use of DI-flux magnetometers and proton magnetometers. The magnetic field variations were measured with the use of PSM magnetometers equipped in Bobrov's quartz variometers. The spare sets are equipped in PSM magnetometers or LEMI flux-gate magnetometers.

Continuous recording has been made by means of microprocessor-based digital loggers DR-02 or DR-03. Owing to the recording system we use and the fact that we strictly obey the procedures relating to the so-called magnetic service, the gaps in one-

minute data from Belsk and Hel are practically absent. Short gaps have only occurred in records of the Hornsund station, because the conditions prevailing there are much harder than in Poland.

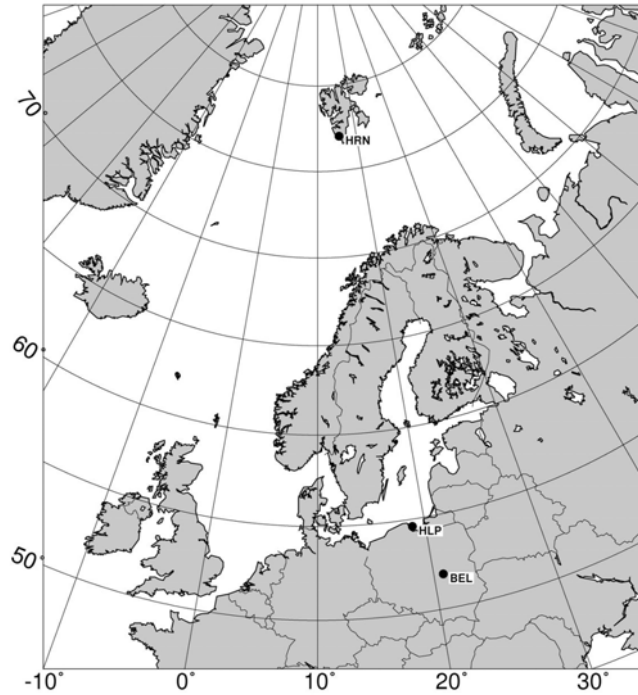

Fig. 1. Location of the Belsk, Hel and Hornsund observatories.

Table 1
Coordinates of the Polish Observatories

| Observatory | Geographic coordinates | | Geomagnetic coordinates | | Elevation [m] |
|----------------|------------------------|------------|-------------------------|-----------|------------------|
| | Latitude | Longitude | Latitude | Longitude | |
| Belsk (BEL) | 51°50.2' N | 20°47.5' E | 50.2°N | 105.2° E | 180 |
| Hel (HLP) | 54°36.5' N | 18°49.0' E | 53.2°N | 104.6° E | 1 |
| Hornsund (HRN) | 77°0.0' N | 15°33.0' E | 73.9°N | 126.0° E | 15 |

It is worth mentioning that in 2007 the Belsk and Hornsund Observatories have been continuing the permanent observation of the Schumann resonance. Two horizontal magnetic components and the vertical component of the electric field have been recorded at a frequency of 100 Hz. This recording was initiated in both observatories in 2004 (Neska and Satori 2006).

2.1 Central Geophysical Observatory at Belsk, Central Poland

The Observatory at Belsk began continuous observations of the Earth magnetic field in 1965 (Jankowski and Marianiuk 2007). It continued the activity of the first Polish magnetic Observatory at Świder near Warsaw, working incessantly through the years 1920-1975. The magnetic observations were transferred from Świder to Belsk because of a strong increase of artificial noise from the Warsaw agglomeration, in particular due to the electric railroad passing nearby the Świder Observatory.

The Belsk Observatory is located at a distance of about 50 km south of Warsaw and about 2 km northwest of the village Belsk Duży. The premises of the Observatory, about 10 ha in area, is at the edge of the forest reserve Modrzewina, far away of people's settlements and automobile traffic. The location of the observatory in relation to the nearby towns and villages is shown in Fig. 2. The Observatory is surrounded by typically agricultural regions (with fertile soil, mostly apple orchards), so the direct neighborhood is deprived of sources of major artificial geomagnetic field disturbances. It is only the electric railroad (DC powered) situated some 14 km away of the Observatory to the north that produces some small artificial magnetic disturbances, whose average level usually does not exceed 1 nT.

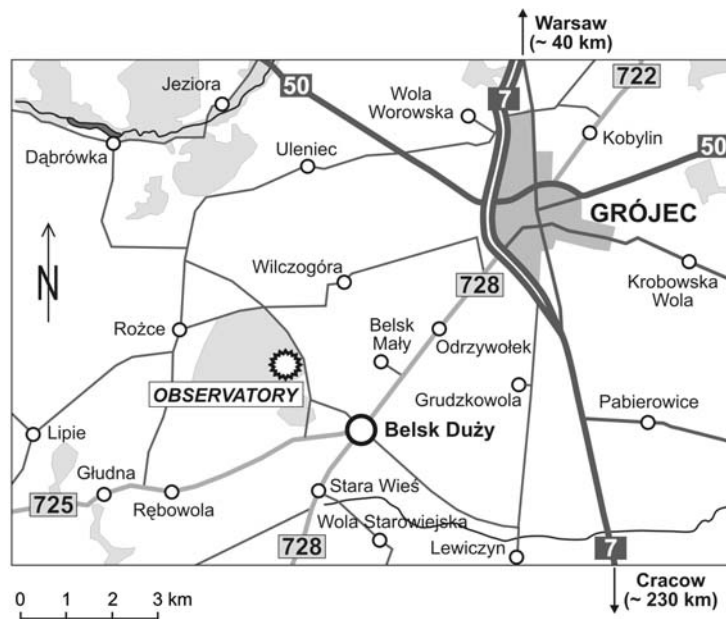

Fig. 2. Location of the Belsk Geophysical Observatory.

More information about the region in which the Observatory is located can be found, in English, Polish and German, on the internet pages of Grójec district (<http://www.grojec.pl>) to which the village Belsk Duży belongs. Relevant information can also be found at page of the Belsk Observatory

(http://www.igf.edu.pl/pl/obserwatoria/cog_belsk).

2.2 Geophysical Observatory at Hel, Northern Poland

The Observatory at Hel began continuous observations of the earth magnetic field in 1932 (Jankowski and Marianiuk 2007). The observations were stopped in 1939, after the outbreak of World War II. During the war, the Observatory as well as its equipment and data were completely destroyed. After reconstruction, continuous observations at Hel were resumed in 1957.

The Hel Observatory is located in a small resort town at the end of Hel Peninsula by the Bay of Gdańsk (see Fig. 3). It is the area of Seaside Landscape Park (Nadmorski Park Krajobrazowy), weakly industrialized and urbanized. The region, surrounded by water from three sides, lacks any major artificial noise and is a good place for continuous magnetic observations.

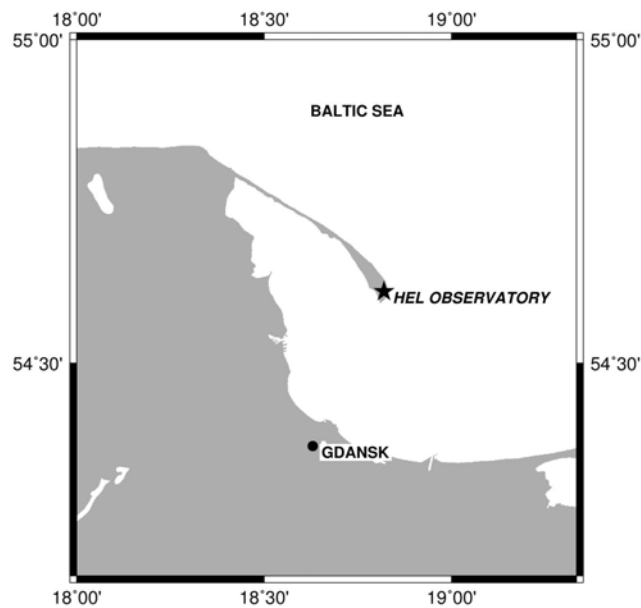

Fig. 3. Location of the Geophysical Observatory at Hel.

The observatory premises, about 4.5 ha in area, is surrounded by mixed forest (mainly pine and birch trees). Pavilions with measurement and recording instruments are located at small clearings.

More information about the town of Hel where the Observatory is located can be found at the address: <http://www.hel-miasto.pl/>.

2.3 Hornsund, Spitsbergen

The Polish Polar Station Hornsund (PSP Hornsund) is situated on the White Bear Bay (Isbjørnhamna) in Hornsund Fiord, Spitsbergen Island, Svalbard Archipelago. (See Fig. 4). More information on the Svalbard Archipelago can be found at the address: <http://svalbard.com>

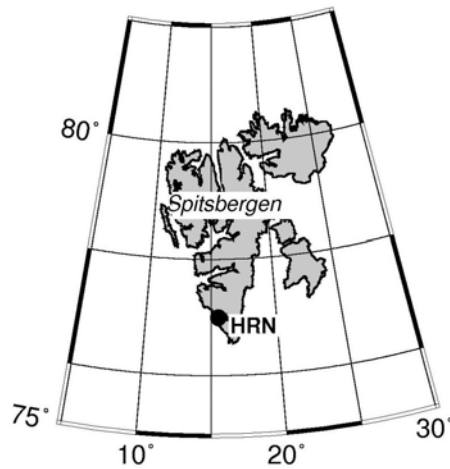

Fig. 4. Location of Polish Polar Station Hornsund.

The Hornsund station is the northernmost Polish scientific facility carrying out year-round activity. The Hornsund region is situated in a zone of strong magnetic field activity, much stronger than on the magnetic pole. Therefore, it is a very interesting place for magnetic observations.

Polish geomagnetic observations in the Arctic were initiated during the II Polar Year; a magnetic station was then established by S. Siedlecki and C. Centkiewicz on the Bear Island. In the years 1932/33, they had carried out continuous recording of magnetic field and performed absolute measurements. In the years 1957/58, in the framework of the International Geophysical Year, measurements of magnetic declination and inclination were made by J. Kowalczyk and K. Karaczun in five sites in the Hornsund Fiord region.

Since the beginning of October 1978, continuous magnetic field recording has been put into operation, and systematic absolute measurements have been implemented (Jankowski and Marianiuk 2007). Since then, PSP Hornsund has begun to fulfill all the requirements for geomagnetic observatory.

Since 1993, PSP Hornsund has been participating in the IMAGE (International Monitor for Auroral Geomagnetic Effects) project. In the framework of this project, Hornsund data are being sent to a server in Finland, once a month on the average. Since 2002, PSP Hornsund is included into the global near-real-time magnetic observatory network INTERMAGNET, sending the results, via Internet, to the GIN (Geomagnetic Information Nodes) centers in Edinburgh and Paris.

3. INSTRUMENTATION

3.1 Introduction

Simplified block diagrams of geomagnetic observations in Belsk, Hel, and Hornsund Observatories are shown in Figs. 5, 6, and 7.

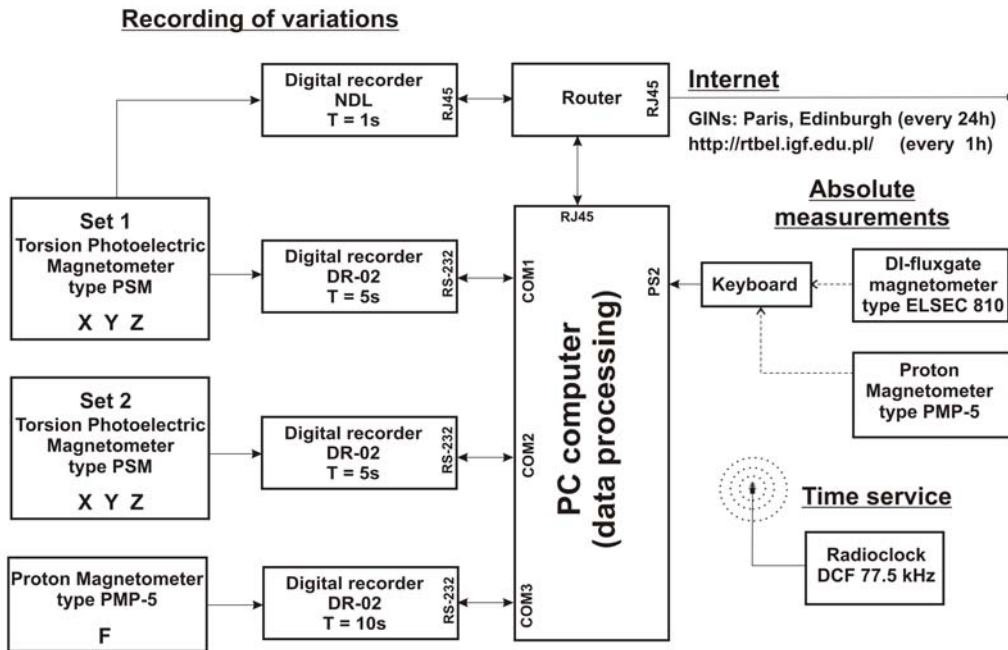

Fig. 5. Block diagram of magnetic observations system at Belsk.

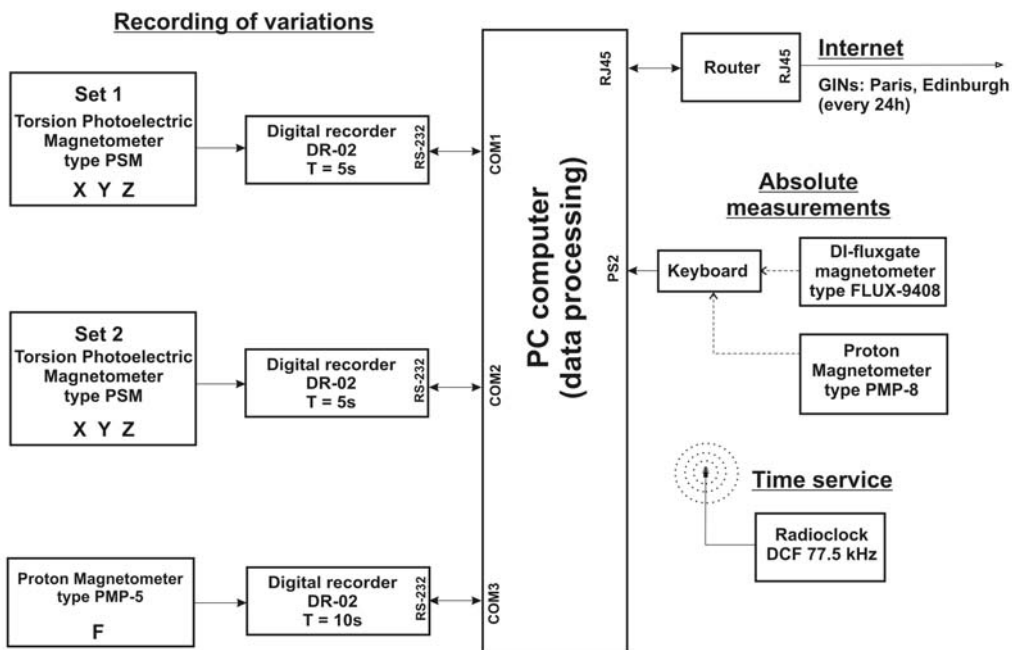

Fig. 6. Block diagram of magnetic observations system at Hel.

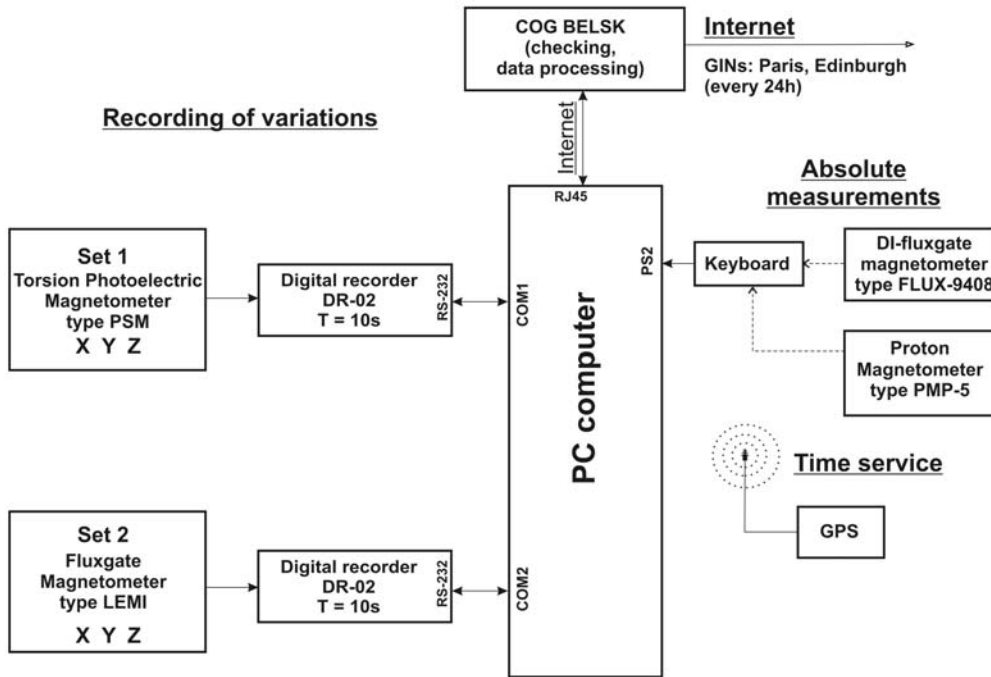

Fig. 7. Block diagram of the magnetic observations system at the Polish Polar Station Hornsund.

3.2 Absolute measurements

In all the three Polish observatories, the absolute measurements used for determination of bases of the recordings are performed by means of DI-flux and proton magnetometers. DI-flux magnetometers measure the absolute values of the angles of declination D and inclination I , while the proton magnetometers measure the absolute values of the total magnetic field vector F . From the measured values of F , D , and I , we can calculate all the remaining magnetic field components, H , X , Y , and Z .

The instruments for absolute measurements are listed in Table 2, and the basic parameters of the instruments in Table 3.

The results of absolute measurements are determined by means of a special computer package DIFLUX, which calculates the base values on the basis of data from the measurement protocol (Tomczyk 2008).

The bases B_A of digital recording of elements X , Y and Z were calculated from the formula:

$$B_A = A - \varepsilon_A \times (a - 32768),$$

where A is the result of absolute measurement [nT], ε_A is the scale value of the recording [nT/bit], a is the recorded instantaneous value [bits].

For the digital records with a resolution of 16 bits, the values of $2^{15} = 32768$ bits, corresponding to zero voltages on inputs of these loggers, were adopted as the base levels.

Table 2
Instruments for absolute measurements

| | Belsk | Hel | Hornsund |
|---------------------------------------|--|-------------------------------------|-------------------------------------|
| DI-fluxgate (fluxgate, theodolite) | ELSEC 810, THEO-10B sn: 002208 | FLUX-9408 THEO-10B sn: 160334 | FLUX-9408 THEO-10B sn: 160326 |
| Proton magnetometer | PMP-5 sn: 128 PMP-8 sn: 13/1998 | PMP-8 sn: 21/2006 | PMP-5 sn: 115 |
| Frequency of measurements | 6 per week | 2 per week | 2 per week |

Table 3
Basic parameters of the instruments for absolute measurements

| | |
|---|--|
| Fluxgate declinometer/inclinometer ELSEC 810 / THEO-10B | |
| Producer | ELSEC Oxford, UK |
| Mean square error of a horizontal direction | $\sigma_D \approx \pm 5''$ |
| Mean square error of a zenith direction | $\sigma_I \approx \pm 5''$ |
| Fluxgate declinometer/inclinometer FLUX-9408 / THEO-10B | |
| Producer (FLUX-9408)..... | Institute of Geophysics Pol. Acad. Sc. |
| Mean square error of a horizontal direction | $\sigma_D \approx \pm 5''$ |
| Mean square error of a zenith direction | $\sigma_I \approx \pm 5''$ |
| Proton magnetometer model PMP-8 | |
| Producer | Institute of Geophysics Pol. Acad. Sc. |
| Resolution | 0.01 nT |
| Absolute accuracy | 0.2 nT |
| Proton magnetometer model PMP-5 | |
| Producer | Institute of Geophysics Pol. Acad. Sc. |
| Resolution | 0.1 nT |
| Absolute accuracy | 0.2 nT |

Results of base determinations and the smoothed values adopted for further computations are depicted in Figs. 8, 9, 17, and 25 in the chapters describing individual observatories.

The mean random errors of a single base measurement, m_B , and the number of measurements n taken in 2007 are listed in Table 4.

Thermal coefficients of magnetic sensors are not taken into account in calculations, with a view to the following facts:

- tests made every few years indicated that the coefficients are very small, less than $0.2 \text{ nT/}^\circ\text{C}$,
- the magnetic sensors are located in thermostat-controlled wooden boxes where the daily temperature variations are of the order of $0.1\text{-}0.2^\circ\text{C}$.

Table 4
Mean errors of measurements of B_X , B_Y and B_Z in 2007

| Observatory | Element | Set I | | Set II | |
|-------------|---------|-------------------------------|--------------------|-------------------------------|--------------------|
| | | Number of measurements [n] | Mean error [mB] | Number of measurements [n] | Mean error [mB] |
| Belsk | B_X | 311 | ± 0.5 nT | 310 | ± 0.5 nT |
| | B_Y | 311 | ± 0.5 nT | 310 | ± 0.6 nT |
| | B_Z | 311 | ± 0.3 nT | 310 | ± 0.3 nT |
| Hel | B_X | 104 | ± 0.5 nT | 104 | ± 0.5 nT |
| | B_Y | 103 | ± 0.5 nT | 104 | ± 0.6 nT |
| | B_Z | 104 | ± 0.3 nT | 104 | ± 0.3 nT |
| Hornsund | B_X | 104 | ± 1.2 nT | – | – |
| | B_Y | 106 | ± 1.0 nT | – | – |
| | B_Z | 104 | ± 0.8 nT | – | – |

3.3 Recording of geomagnetic field variations

As we already mentioned, the continuous digital recordings of geomagnetic field variations in all the Polish observatories are performed by means of magnetometers PSM and digital loggers DR-02 (or DR-03). In spare sets, we use magnetometers PSM or LEMI. Both the main and spare sets record the components in the rectangular coordinate system X, Y, Z. At Belsk and Hel, continuous recording of the total magnetic field modulus F is performed as well. The basic parameters of the recording systems are listed in Table 5.

Magnetometers PSM

Magnetometers PSM were designed at the Institute of Geophysics PAS with the use of torsion quartz variometers of V.N. Bobrov system (Marianiuk 1977, Jankowski *et al.* 1984). In these magnetometers, the magnet's deflections in response to the magnetic field changes are transformed by means of photoelectric converters into the electric current changes. Owing to a strong negative feedback, the voltage changes on the output of the converter are in linear proportion to the magnetic field changes. The magnetometers PSM are characterized by good stability, of about 3-5 nT/year, and small noise, below 10 pT.

Magnetometers LEMI

Magnetometers LEMI were designed at the Lviv Centre of the Institute of Space Research (Ukraine). They employ flux-gate sensors. These magnetometers have been

successfully used as auxiliary sets. Their stability is not much less than that of PSM's, and they are also characterized by good orthogonality of sensors and relatively small self noise.

Table 5
Basic instruments for the magnetic field variations recording

| | | Belsk | Hel | Hornsund |
|-------------|--|--------------------------------|--------------------------------|--------------------------------|
| SET 1 | Name of magnetometer Kind of sensor | PSM Bobrov | PSM Bobrov | PSM Bobrov |
| | Type | PSM-8511-01P | PSM 8511-09P | PSM-8911-05P |
| | Sensor's orientation | XYZ | XYZ | XYZ |
| | Range | +/- 850 nT | +/- 850 nT | +/- 5000 nT |
| | Magnetometer's producer | Institute of Geophysics PAS | Institute of Geophysics PAS | Institute of Geophysics PAS |
| | Digital recorder Producer | DR-02, DR-03 EL-LAB | DR-03 EL-LAB | DR-02 EL-LAB |
| | Sampling interval | 5 s and 1 s | 5 s | 10 s |
| SET 2 | Name of magnetometer Kind of sensor | PSM Bobrov | PSM Bobrov | LEMI fluxgate |
| | Type | PSM-8511-01P | PSM 8511-03P | LEMI-003/95 |
| | Sensor's orientation | XYZ | XYZ | XYZ |
| | Range | +/- 820 nT | +/- 820 nT | +/- 10.000 nT |
| | Magnetometer's producer | Institute of Geophysics PAS | Institute of Geophysics PAS | Institute of Geophysics PAS |
| | Digital recorder Producer | DR-02, DR-03 EL-LAB | DR-02 EL-LAB | DR-02 EL-LAB |
| | Sampling interval | 5 s and 1 s | 5 s | 10 s |
| Total field | Name of magnetometer | PMP-5 | PMP-5 | – |
| | Producer | Institute of Geophysics PAS | Institute of Geophysics PAS | Institute of Geophysics PAS |
| | Sampling interval | 10 s | 10 s | – |

Proton magnetometers PMP-5 and PMP-8

Magnetometers PMP-5 and PMP-8 were designed at the Institute of Geophysics PAS. These are classical proton magnetometers, in which the precession signal is forced in a cycle of proton polarization by means of direct current. The resolution of magnetometers PMP-5 is 0.1 nT, that of PMP-8 being 0.01 nT. The stability of both

magnetometers is better than 0.3 nT/year. More information about PMP-8 magnetometer can be found on the page:

http://www.igf.edu.pl/pl/zaklady_naukowe/konstrukcji_aparatury/aparatura

Digital loggers DR-02 and DR-03

The digital loggers were designed in the early 1990s by the enterprise EL-LAB (Poland) especially for recording the long-term slow-changing variations. These are independent instruments and their cooperation with the computer resolves itself to the read-out of data via the RS-232 interface. Model DR-03 is equipped in clock synchronized by a GPS.

3.4 Calibration of magnetic sensors

The verification of scale values of recording systems in all the three observatories was made by the classical electromagnetic method: electric currents were passed through calibration coils woven over variometers. The currents induce the magnetic field of precisely known intensity. The measurements are made at least few times a year.

The scale values of magnetometers PSM and LEMI, parameters of calibration coils of PSMs, and mutual orthogonality of sensors in PSMs and LEMIs is checked every few years in large calibration coils installed at the Belsk Observatory.

Table 6

Scale values adopted for computations in 2007

| Observatory | Set | Period | Scale values | | |
|-------------|--------|---------------|--------------|------------|------------|
| | | | X [nT/bit] | Y [nT/bit] | Z [nT/bit] |
| Belsk | Set I | Jan 01-Dec 31 | 0.0250 | 0.0249 | 0.0249 |
| | Set II | Jan 01-Dec 31 | 0.0249 | 0.0249 | 0.0249 |
| Hel | Set I | Jan 01-Dec 31 | 0.0249 | 0.0249 | 0.0249 |
| | Set II | Jan 01-Dec 31 | 0.0249 | 0.0249 | 0.0250 |
| Hornsund | Set I | Jan 01-Dec 31 | 0.149 | 0.151 | 0.149 |
| | Set II | Jan 01-Dec 31 | 0.307 | 0.308 | 0.307 |

3.5 Data treatment

In processing the results of digital recordings we used the software packet developed for the needs of an observatory operating in the INTERMAGNET network. This software makes it possible to perform, among other things, the following operations:

- conversion of magnetic data into the INTERMAGNET text format IMFV1.22 and creation in this format of daily files containing one-minute means of X, Y, Z and F (authors: J. Reda and A. Pałka),

- automatic transmission of data, via the Internet, to the Institute of Geophysics PAS in Warsaw and data centers in Paris and Edinburgh (author: M. Neska),
- archivation of data and plotting of magnetograms (author: J. Reda),
- calculation of results of absolute measurements (author: S. Tomczyk),
- automatic calculation of geomagnetic indices K and C (Nowożyński et al. 1991). The indices are calculated with the use of ASm (Adaptive Smoothed) method, developed at the Institute of Geophysics PAS, and recommended by IAGA in 1991. The currently used program calculates the indices from one-minute means in the INTERMAGNET CD-ROM Data Format or in the IMFV1.22 format. The program for calculation of indices may be taken from the INTERMAGNET page:
http://www.intermagnet.org/Software_e.html
- test printouts to check various parameters of recording adopted for calculation and a possibility of looking over current and past data curves or tables.

The diagrams illustrating the annual variations of X, Y, and Z, monthly variations of X, Y, Z and F, bases of recording sets as well as plots of K indices for 2007 were prepared with the use of program `imagplot.exe` provided to us by INTERMAGNET. The diagrams prepared by means of `imagplot.exe` and other diagrams related to 2007 data are shown in Figs. 8 through 31 in the further part of this report.

3.6 Data availability

The newest data from Belsk, Hel and Hornsund observatories can be viewed in graphic form through the WEB application

<http://rtbel.igf.edu.pl>

described by Nowożyński and Reda (2007).

On this page, the Belsk data appear with one-hour delay. The Hel data are made available a few hours after the end of the day, while the delay for Hornsund is 2 days on the average. The page makes it possible to view the archival data from any observatory belonging to the INTERMAGNET network (in the form of curves on the screen). It offers also a possibility of calculating the K indices according to the ASm method (Nowożyński *et al.* 1991) and E indices (Reda and Jankowski 2004).

The current data (of status REPORTED) from all the three observatories can be found in INTERMAGNET at the Internet address:

http://www.intermagnet.org/apps/dl_data_prel_e.php

Data from Belsk, Hel and Hornsund are also available from the WDCs. Addresses of some WDC pages with magnetic data are the following:

WDC for Geomagnetism, Edinburgh. <http://www.wdc.bgs.ac.uk/catalog/master.html>

WDC for Geomagnetism, Kyoto. <http://swdc234.kugi.kyoto-u.ac.jp/>

All the three observatories have in their archives the original data, whose sampling periods are listed in Table 5. For those interested, these data can be made available on request.

4. CONTACT PERSON, POSTAL ADDRESS, CONTACT DETAILS

4.1 Belsk Observatory

Jan Reda, Mariusz Neska
 Central Geophysical Observatory
 05-622 Belsk
 Poland
 Tel.: +48 486610830 Fax: +48 486610840
 E-mail: jreda@igf.edu.pl (J. Reda), nemar@igf.edu.pl (M. Neska)
http://www.igf.edu.pl/pl/obserwatoria/cog_belsk

4.2 Hel Observatory

Stanisław Wójcik
 Geophysical Observatory
 ul. Sosnowa 1
 84-150 Hel
 Poland
 Tel./Fax +48 58 6750480
 E-mail: hel@igf.edu.pl
<http://www.igf.edu.pl>

4.3 Hornsund

Mariusz Neska
 Central Geophysical Observatory
 05-622 Belsk
 Poland
 Tel.: +48 486610833 Fax: +48 486610840
 E-mail: nemar@igf.edu.pl
<http://hornsund.igf.edu.pl>, <http://www.igf.edu.pl>

5. PERSONNEL TAKING PART IN THE WORK OF BELSK, HEL AND HORNSUND OBSERVATORIES IN 2007

5.1 Belsk

- Jan Reda (head of Geomagnetic Laboratory at Belsk)
- Janusz Marianiuk (consulting)
- Mariusz Neska (data processing)
- Halina Suska (data processing, observer)
- Krzysztof Kucharski (observer)
- Benedykt Pachocki (observer)
- Józef Skowroński (observer)

5.2 Hel

- Stanisław Wójcik (head of Geophysical Observatory)
- Anna Wójcik (observer)

- Mariusz Neska (data processing)
- Jan Reda (data processing)

5.3 Hornsund

- Mariusz Neska (head of geomagnetic observations)
- Piotr Modzel (observer in 1-st half-year)
- Jarosław Czyszczek (observer in 1-st half-year)
- Paweł Czubak (observer in 2-nd half-year)
- Jan Reda (data processing)

References

- Jankowski, J., and C. Sucksdorff (1996), *Guide for Magnetic Measurements and Observatory Practice*, IAGA, Warsaw, 235 pp.
- Jankowski, J., J. Marianiuk, A. Ruta, C. Sucksdorff, and M. Kivinen (1984), Long-term stability of a torque-balance variometer with photoelectric converters in observatory practice, *Geophys. Surv.* **6**, 3/4, 367-380.
- Jankowski, J., and J. Marianiuk (2007), Past and present of Polish geomagnetic observatories, *Publs. Inst. Geophys. Pol. Acad. Sc.* **C-99 (398)**, 20-31.
- Marianiuk, J. (1977), Photoelectric converter for recording the geomagnetic field elements: construction and principle of operation, *Publs. Inst. Geophys. Pol. Acad. Sc.* **C-4 (114)**, 57-73.
- Neska, M., and G. Satori (2006), Schumann resonance observation at Polish Polar Station at Spitsbergen and in Central Geophysical Observatory in Belsk, Poland, *Przepl. Geofiz.* **3-4**, 189-198, (in Polish).
- Nowożyński, K., T. Ernst, and J. Jankowski (1991), Adaptive smoothing method for computer derivation of K-indices, *Geophys. J. Int.* **104**, 85-93.
- Nowożyński, K., and J. Reda (2007), Comparison of observatory data in quasi-real time, *Publs. Inst. Geophys. Pol. Acad. Sc.* **C-99 (398)**, 123-127.
- Reda, J., and M. Neska (2007), Measurement Session during the XII IAGA Workshop at Belsk, *Publs. Inst. Geophys. Pol. Acad. Sc.* **C-99 (398)**, 7-19.
- Reda, J., and J. Jankowski (2004), Three hour activity index based on power spectra estimation, *Geophys. J. Int.* **157**, 141-146.
- Reda, J. (editor) (2007), XII IAGA Workshop on Geomagnetic Observatory Instruments, Data Acquisition and Processing, Belsk, 19-24 June 2006, Monographic Volume, *Publs. Inst. Geophys. Pol. Acad. Sc.* **C-99 (398)**, 397 pp.
- Tomczyk, S. (2008), DIFLUX software package for calculation of absolute measurement results, *Publs. Inst. Geophys. Pol. Acad. Sc.* **C-100 (402)**, 61-67.
- Technical data of PMP-8:
http://www.igf.edu.pl/pl/zaklady_naukowe/konstrukcji_aparatury/aparatura

Received December 1, 2008
 Accepted December 8, 2008

Tables and plots for Belsk Observatory

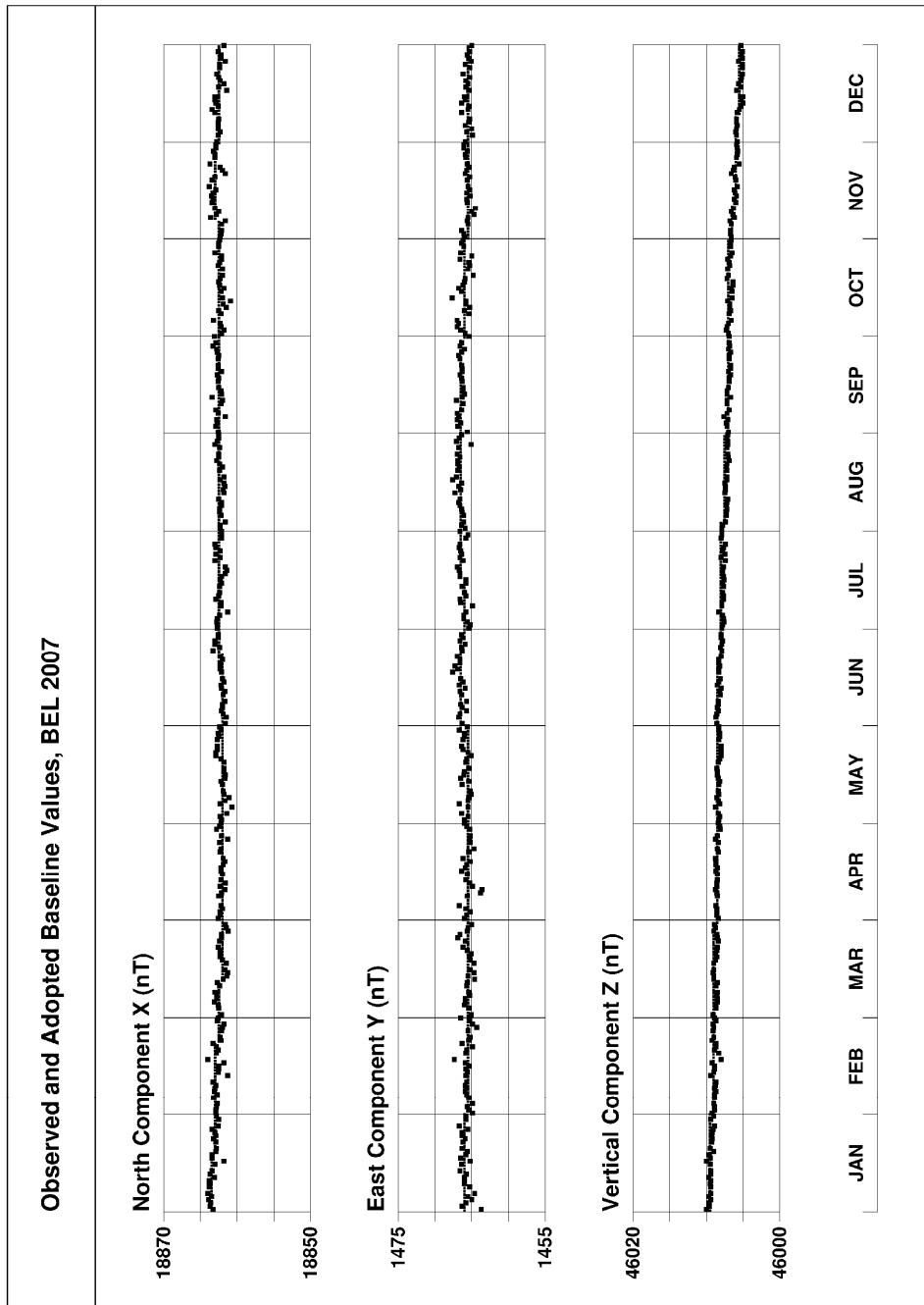

Fig. 8. Base values of set 1, Belsk 2007.

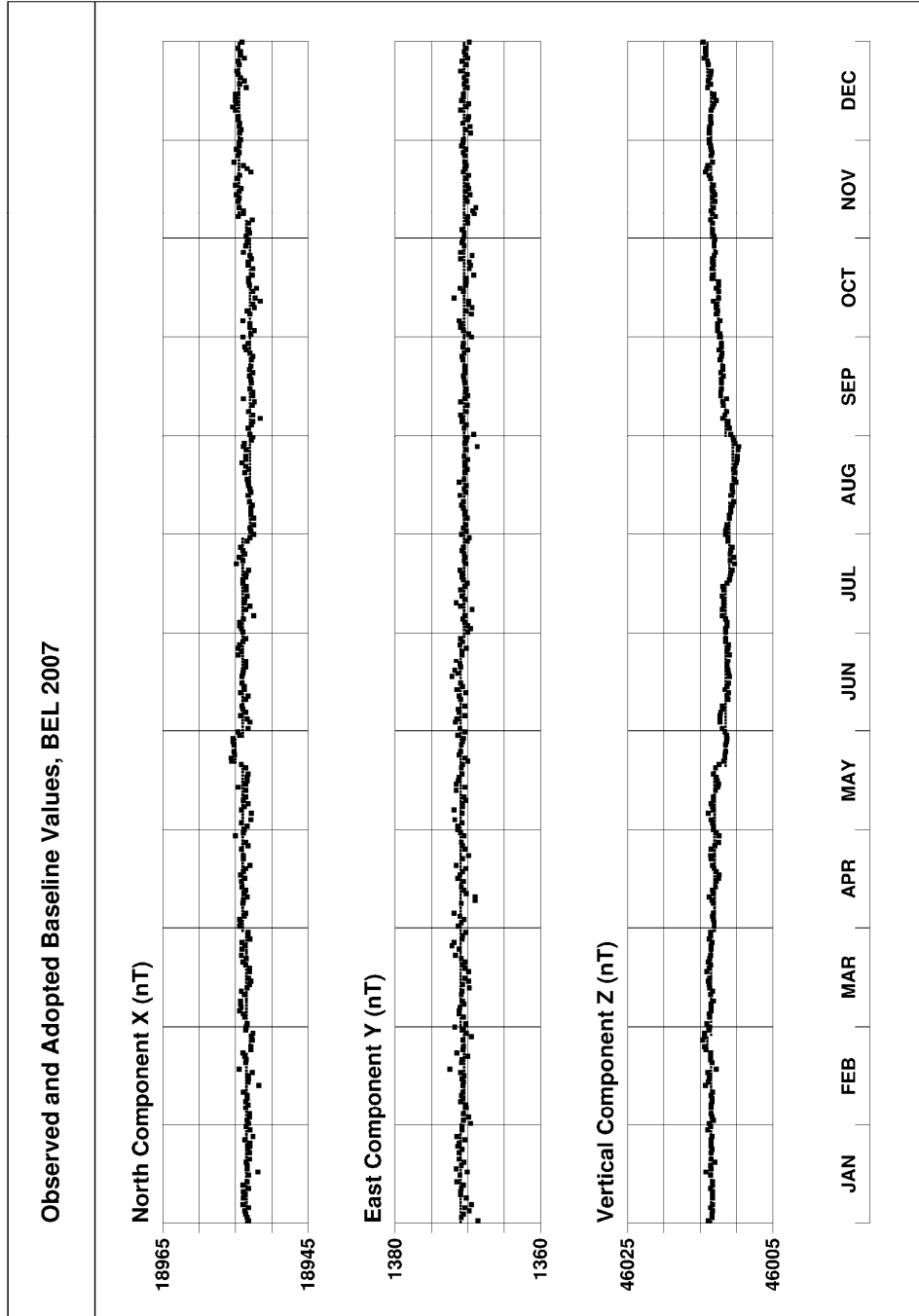

Fig. 9. Base values of set 2, Belsk 2007.

Annual mean values of magnetic elements in Belsk Observatory

| No | Year | D [° ‘] | H [nT] | Z [nT] | X [nT] | Y [nT] | I [° ‘] | F [nT] |
|----|------|--------------|-------------|-------------|-------------|-------------|--------------|-------------|
| 1 | 1966 | 2 04.2 | 18901.2 | 45023.3 | 18888.9 | 682.8 | 67 13.6’ | 48829.8 |
| 2 | 1967 | 2 05.6 | 18906.2 | 45047.7 | 18893.6 | 690.7 | 67 14.0 | 48854.3 |
| 3 | 1968 | 2 06.2 | 18917.8 | 45071.3 | 18905.5 | 694.6 | 67 13.8 | 48880.5 |
| 4 | 1969 | 2 06.3 | 18935.7 | 45093.5 | 18922.9 | 695.6 | 67 13.3 | 48907.9 |
| 5 | 1970 | 2 06.6 | 18953.0 | 45123.1 | 18940.2 | 697.7 | 67 13.0 | 48941.9 |
| 6 | 1971 | 2 06.6 | 18975.5 | 45146.4 | 18962.6 | 698.8 | 67 12.2 | 48972.1 |
| 7 | 1972 | 2 08.0 | 18991.6 | 45176.3 | 18978.4 | 706.7 | 67 11.9 | 49005.9 |
| 8 | 1973 | 2 10.2 | 19004.6 | 45210.8 | 18991.0 | 719.4 | 67 12.0 | 49042.8 |
| 9 | 1974 | 2 13.3 | 19016.3 | 45245.6 | 19002.0 | 737.1 | 67 12.2 | 49079.3 |
| 10 | 1975 | 2 16.4 | 19035.2 | 45273.5 | 19020.2 | 754.9 | 67 11.7 | 49112.4 |
| 11 | 1976 | 2 18.5 | 19049.7 | 45306.9 | 19034.3 | 767.3 | 67 11.7 | 49148.8 |
| 12 | 1977 | 2 22.0 | 19062.1 | 45336.6 | 19045.8 | 787.4 | 67 11.7 | 49181.0 |
| 13 | 1978 | 2 27.4 | 19058.6 | 45375.7 | 19041.1 | 817.1 | 67 13.0 | 49215.7 |
| 14 | 1979 | 2 32.3 | 19061.4 | 45401.4 | 19042.7 | 844.2 | 67 13.5 | 49240.5 |
| 15 | 1980 | 2 37.2 | 19063.2 | 45418.4 | 19043.3 | 871.2 | 67 13.9 | 49256.8 |
| 16 | 1981 | 2 42.9 | 19047.1 | 45448.9 | 19025.7 | 902.0 | 67 15.7 | 49278.7 |
| 17 | 1982 | 2 48.3 | 19034.8 | 45478.8 | 19012.0 | 931.3 | 67 17.3 | 49301.6 |
| 18 | 1983 | 2 52.4 | 19032.6 | 45498.8 | 19008.7 | 953.8 | 67 18.0 | 49319.2 |
| 19 | 1984 | 2 56.9 | 19022.8 | 45519.8 | 18997.6 | 978.4 | 67 19.2 | 49334.8 |
| 20 | 1985 | 3 00.8 | 19015.2 | 45542.0 | 18988.9 | 999.5 | 67 20.3 | 49352.3 |
| 21 | 1986 | 3 05.1 | 19003.3 | 45570.4 | 18975.8 | 1022.8 | 67 21.8 | 49373.9 |
| 22 | 1987 | 3 08.5 | 18999.1 | 45592.7 | 18970.6 | 1041.2 | 67 22.7 | 49392.9 |
| 23 | 1988 | 3 12.4 | 18983.0 | 45626.4 | 18953.3 | 1062.0 | 67 24.6 | 49417.8 |
| 24 | 1989 | 3 15.9 | 18966.2 | 45662.1 | 18935.4 | 1080.3 | 67 26.6 | 49444.3 |
| 25 | 1990 | 3 18.8 | 18961.5 | 45684.3 | 18929.8 | 1095.9 | 67 27.5 | 49463.1 |
| 26 | 1991 | 3 22.2 | 18950.8 | 45709.3 | 18918.0 | 1114.1 | 67 28.8 | 49482.0 |
| 27 | 1992 | 3 25.3 | 18954.8 | 45726.1 | 18921.0 | 1131.2 | 67 29.1 | 49499.1 |
| 28 | 1993 | 3 29.8 | 18956.4 | 45743.7 | 18921.1 | 1156.0 | 67 29.4 | 49516.0 |
| 29 | 1994 | 3 34.8 | 18953.6 | 45772.4 | 18916.6 | 1183.3 | 67 30.4 | 49541.4 |
| 30 | 1995 | 3 39.8 | 18959.3 | 45796.8 | 18920.6 | 1211.5 | 67 30.7 | 49566.2 |
| 31 | 1996 | 3 45.0 | 18965.7 | 45821.9 | 18925.1 | 1240.6 | 67 30.9 | 49591.8 |
| 32 | 1997 | 3 50.9 | 18962.8 | 45856.9 | 18920.0 | 1272.7 | 67 32.0 | 49623.0 |
| 33 | 1998 | 3 57.3 | 18955.8 | 45897.1 | 18910.6 | 1307.6 | 67 33.6 | 49657.5 |
| 34 | 1999 | 4 02.5 | 18957.8 | 45930.6 | 18910.6 | 1336.4 | 67 34.3 | 49689.2 |
| 35 | 2000 | 4 07.8 | 18955.4 | 45968.7 | 18906.2 | 1365.4 | 67 35.5 | 49723.5 |
| 36 | 2001 | 4 13.0 | 18962.4 | 46004.8 | 18911.1 | 1394.2 | 67 36.0 | 49759.6 |
| 37 | 2002 | 4 18.4 | 18969.2 | 46043.6 | 18915.6 | 1424.4 | 67 36.6 | 49798.0 |
| 38 | 2003 | 4 24.2 | 18970.2 | 46089.6 | 18914.2 | 1456.7 | 67 37.7 | 49840.9 |
| 39 | 2004 | 4 29.4 | 18980.3 | 46121.0 | 18922.0 | 1486.0 | 67 37.9 | 49873.8 |
| 40 | 2005 | 4 34.7 | 18984.3 | 46154.6 | 18923.7 | 1515.5 | 67 38.5 | 49906.4 |
| 41 | 2006 | 4 39.8 | 18996.7 | 46177.2 | 18933.8 | 1544.3 | 67 38.3 | 49932.0 |
| 42 | 2007 | 4 45.8 | 19007.4 | 46206.7 | 18941.8 | 1578.4 | 67 38.4 | 49963.4 |

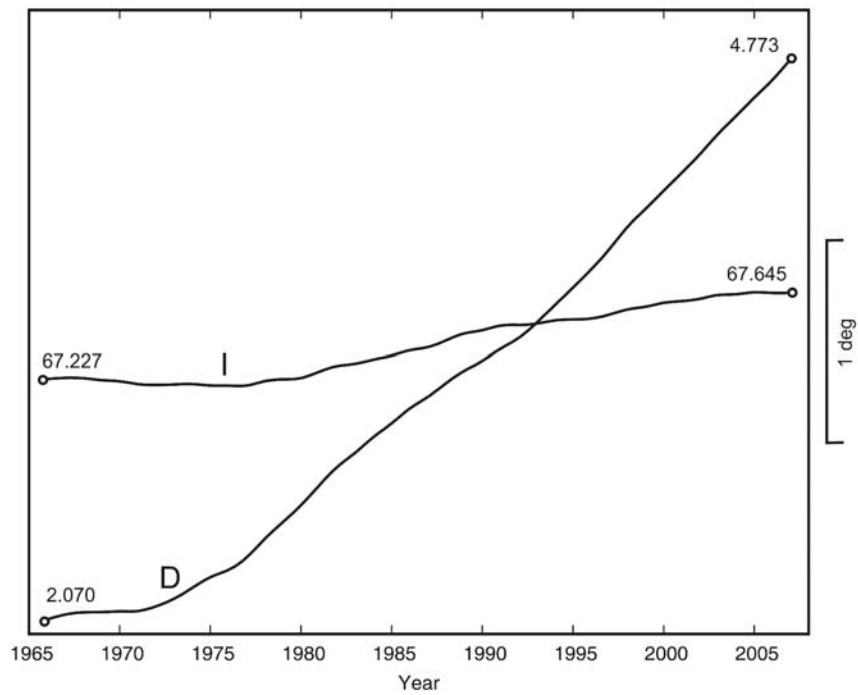
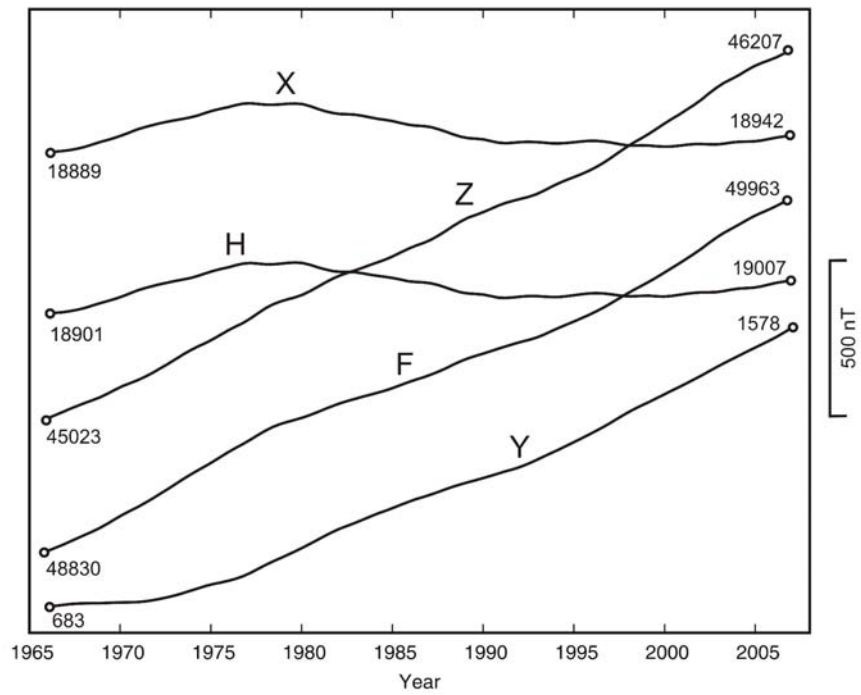

Fig. 10. Secular changes of H, X, Y, Z, F, D and I at Belsk.

MONTHLY AND YEARLY MEAN VALUES OF MAGNETIC ELEMENTS

BELSK **2007**

| | JAN | FEB | MAR | APR | MAY | JUN | JUL | AUG | SEP | OCT | NOV | DEC | MEAN |
|----------------|---------------------------------------|-----|-----|-----|-----|-----|-----|-----|-----|-----|-----|-----|------|
| | NORTH COMPONENT: 18500 + ... in nT | | | | | | | | | | | | |
| All days | 434 | 438 | 439 | 441 | 444 | 447 | 444 | 445 | 442 | 440 | 443 | 445 | 442 |
| Quiet days | 438 | 442 | 442 | 445 | 447 | 446 | 447 | 446 | 445 | 446 | 448 | 450 | 445 |
| Disturbed days | 427 | 434 | 434 | 432 | 439 | 450 | 443 | 445 | 437 | 433 | 431 | 436 | 437 |
| | EAST COMPONENT: 1000 + ... in nT | | | | | | | | | | | | |
| All days | 564 | 566 | 567 | 570 | 573 | 576 | 580 | 582 | 586 | 588 | 592 | 595 | 578 |
| Quiet days | 562 | 564 | 566 | 569 | 572 | 576 | 580 | 582 | 584 | 586 | 589 | 592 | 577 |
| Disturbed days | 568 | 569 | 570 | 575 | 577 | 576 | 580 | 584 | 588 | 593 | 598 | 599 | 581 |
| | VERTICAL COMPONENT: 46000 + ... in nT | | | | | | | | | | | | |
| All days | 199 | 199 | 199 | 199 | 202 | 204 | 207 | 209 | 210 | 215 | 217 | 220 | 207 |
| Quiet days | 197 | 198 | 198 | 198 | 199 | 203 | 206 | 208 | 210 | 213 | 215 | 218 | 205 |
| Disturbed days | 199 | 199 | 199 | 200 | 204 | 205 | 209 | 208 | 210 | 217 | 222 | 223 | 208 |

Three-hour-range K indices
Belsk, January - March, 2007
The limit of K=9 is 450

| Day | January | | | February | | | March | | |
|-----|---------|------|----|----------|------|----|-------|------|----|
| | K | SK | | K | SK | | K | SK | |
| 1 | 1112 | 4332 | 17 | 3122 | 2143 | 18 | 4222 | 3311 | 18 |
| 2 | 5323 | 5333 | 27 | 1121 | 1221 | 11 | 1121 | 1122 | 11 |
| 3 | 2333 | 4434 | 26 | 1101 | 1000 | 4 | 0010 | 0111 | 4 |
| 4 | 2333 | 3433 | 24 | 0011 | 0012 | 5 | 0111 | 1033 | 10 |
| 5 | 2222 | 3322 | 18 | 2001 | 2222 | 11 | 3113 | 2252 | 19 |
| 6 | 1211 | 1321 | 12 | 1222 | 1212 | 13 | 3423 | 3223 | 22 |
| 7 | 0001 | 1101 | 4 | 3223 | 2253 | 22 | 4333 | 3333 | 25 |
| 8 | 1100 | 1221 | 8 | 2322 | 2322 | 18 | 2111 | 0121 | 9 |
| 9 | 0111 | 1221 | 9 | 2221 | 1122 | 13 | 0001 | 1122 | 7 |
| 10 | 0222 | 2321 | 14 | 2111 | 0232 | 12 | 2111 | 1231 | 12 |
| 11 | 1222 | 2231 | 15 | 0100 | 0032 | 6 | 1012 | 2333 | 15 |
| 12 | 3001 | 1100 | 6 | 1012 | 3323 | 15 | 1213 | 3344 | 21 |
| 13 | 0000 | 0000 | 0 | 2322 | 2456 | 26 | 5334 | 4443 | 30 |
| 14 | 0011 | 2113 | 9 | 4233 | 2352 | 24 | 3323 | 3331 | 21 |
| 15 | 2222 | 5442 | 23 | 3422 | 2332 | 21 | 1222 | 2334 | 19 |
| 16 | 0411 | 3344 | 20 | 2121 | 2334 | 18 | 4211 | 3224 | 19 |
| 17 | 4333 | 3364 | 29 | 2212 | 3323 | 18 | 3222 | 1220 | 14 |
| 18 | 3333 | 3454 | 28 | 2012 | 2232 | 14 | 0012 | 2212 | 10 |
| 19 | 3322 | 3234 | 22 | 0001 | 1211 | 6 | 0011 | 1111 | 6 |
| 20 | 3222 | 1233 | 18 | 0011 | 0101 | 4 | 0000 | 1111 | 4 |
| 21 | 2332 | 2230 | 17 | 1100 | 0000 | 2 | 0011 | 1101 | 5 |
| 22 | 1011 | 1230 | 9 | 0000 | 1212 | 6 | 1111 | 0111 | 7 |
| 23 | 1111 | 0110 | 6 | 2110 | 0121 | 8 | 1122 | 3334 | 19 |
| 24 | 0001 | 0121 | 5 | 2011 | 0011 | 6 | 3323 | 3222 | 20 |
| 25 | 0011 | 0113 | 7 | 2100 | 1231 | 10 | 2124 | 3122 | 17 |
| 26 | 1111 | 1102 | 8 | 2322 | 0000 | 9 | 1112 | 2422 | 15 |
| 27 | 1111 | 1013 | 9 | 0132 | 1354 | 19 | 2223 | 2342 | 20 |
| 28 | 3201 | 1122 | 12 | 3443 | 2435 | 28 | 3212 | 1221 | 14 |
| 29 | 3222 | 6664 | 31 | | | | 0110 | 0112 | 6 |
| 30 | 3433 | 4444 | 29 | | | | 3112 | 1000 | 8 |
| 31 | 3223 | 3554 | 27 | | | | 0121 | 2112 | 10 |

Three-hour-range K indices

Belsk, April - June, 2007

The limit of K=9 is 450

| Day | April | | | May | | | June | | |
|-----|-------|------|----|------|------|----|------|------|----|
| | K | SK | | K | SK | | K | SK | |
| 1 | 5333 | 4345 | 30 | 2221 | 1222 | 14 | 2213 | 1332 | 17 |
| 2 | 3433 | 3343 | 26 | 1110 | 0101 | 5 | 2223 | 1322 | 17 |
| 3 | 3221 | 1432 | 18 | 1011 | 2320 | 10 | 2222 | 3433 | 21 |
| 4 | 2312 | 2123 | 16 | 1001 | 1011 | 5 | 3212 | 3331 | 18 |
| 5 | 1111 | 1212 | 10 | 1000 | 1001 | 3 | 0101 | 1212 | 8 |
| 6 | 2110 | 1111 | 8 | 0000 | 0011 | 2 | 0201 | 0111 | 6 |
| 7 | 3100 | 0100 | 5 | 1133 | 4534 | 24 | 1111 | 1111 | 8 |
| 8 | 0011 | 1113 | 8 | 2333 | 3332 | 22 | 2322 | 3223 | 19 |
| 9 | 3333 | 1112 | 17 | 1222 | 3222 | 16 | 1122 | 2222 | 14 |
| 10 | 2102 | 3333 | 17 | 1011 | 1232 | 11 | 2223 | 1121 | 14 |
| 11 | 2211 | 1011 | 9 | 0101 | 2221 | 9 | 1011 | 0222 | 9 |
| 12 | 2222 | 3321 | 17 | 1112 | 1101 | 8 | 0111 | 1111 | 7 |
| 13 | 1001 | 0010 | 3 | 1101 | 0110 | 5 | 0022 | 1332 | 13 |
| 14 | 0111 | 2213 | 11 | 0112 | 0121 | 8 | 3334 | 3434 | 27 |
| 15 | 3222 | 2210 | 14 | 1112 | 2122 | 12 | 2222 | 2211 | 14 |
| 16 | 0010 | 0000 | 1 | 1111 | 1113 | 10 | 2312 | 3321 | 17 |
| 17 | 0122 | 3434 | 19 | 1101 | 2123 | 11 | 2222 | 3221 | 16 |
| 18 | 3311 | 1233 | 17 | 3244 | 5333 | 27 | 1112 | 1231 | 12 |
| 19 | 2112 | 1112 | 11 | 2233 | 3332 | 21 | 2121 | 2211 | 12 |
| 20 | 1101 | 1112 | 8 | 3212 | 1222 | 15 | 1111 | 1211 | 9 |
| 21 | 0100 | 0111 | 4 | 2101 | 1223 | 12 | 1224 | 4434 | 24 |
| 22 | 2213 | 3333 | 20 | 2122 | 4444 | 23 | 3223 | 3324 | 22 |
| 23 | 4542 | 1200 | 18 | 4343 | 4354 | 30 | 3322 | 2222 | 18 |
| 24 | 1112 | 1122 | 11 | 5332 | 4444 | 29 | 2222 | 3231 | 17 |
| 25 | 2111 | 3210 | 11 | 1223 | 3442 | 21 | 1111 | 2211 | 10 |
| 26 | 2111 | 2323 | 15 | 2323 | 3432 | 22 | 0211 | 2111 | 9 |
| 27 | 2113 | 2455 | 23 | 2333 | 3432 | 23 | 2111 | 1112 | 10 |
| 28 | 4334 | 4444 | 30 | 2212 | 2001 | 10 | 1101 | 2212 | 10 |
| 29 | 4444 | 3333 | 28 | 0111 | 2211 | 9 | 1212 | 2343 | 18 |
| 30 | 4332 | 2321 | 20 | 1111 | 1111 | 8 | 2211 | 1111 | 10 |
| 31 | | | | 1111 | 1122 | 10 | | | |

Three-hour-range K indices
Belsk, July - September, 2007
The limit of K=9 is 450

| Day | July | | | August | | | September | | |
|-----|------|------|----|--------|------|----|-----------|------|----|
| | K | SK | | K | SK | | K | SK | |
| 1 | 1112 | 2212 | 12 | 4333 | 3333 | 25 | 1123 | 2334 | 19 |
| 2 | 1121 | 2100 | 8 | 2122 | 2211 | 13 | 5323 | 4343 | 27 |
| 3 | 1112 | 2323 | 15 | 1111 | 2212 | 11 | 3223 | 3323 | 21 |
| 4 | 3235 | 4431 | 25 | 0111 | 0101 | 5 | 2222 | 2122 | 15 |
| 5 | 2112 | 2122 | 13 | 0001 | 0112 | 5 | 3332 | 2233 | 21 |
| 6 | 1112 | 2331 | 14 | 1012 | 2346 | 19 | 3212 | 1335 | 20 |
| 7 | 2221 | 2222 | 15 | 4333 | 3444 | 28 | 3321 | 2321 | 17 |
| 8 | 2111 | 1110 | 8 | 2221 | 2112 | 13 | 2122 | 2231 | 15 |
| 9 | 0111 | 1010 | 5 | 1112 | 1111 | 9 | 0111 | 1101 | 6 |
| 10 | 0121 | 1124 | 12 | 1113 | 4543 | 22 | 1111 | 0110 | 6 |
| 11 | 4445 | 3421 | 27 | 2222 | 2343 | 20 | 0001 | 1111 | 5 |
| 12 | 2231 | 2221 | 15 | 2212 | 1111 | 11 | 1111 | 1001 | 6 |
| 13 | 1101 | 1112 | 8 | 1111 | 1101 | 7 | 0111 | 1021 | 7 |
| 14 | 2223 | 4563 | 27 | 1001 | 1113 | 8 | 2001 | 2332 | 13 |
| 15 | 4232 | 1221 | 17 | 3311 | 2332 | 18 | 2012 | 2222 | 13 |
| 16 | 1112 | 1121 | 10 | 2122 | 1121 | 12 | 1111 | 1210 | 8 |
| 17 | 1111 | 1010 | 6 | 2111 | 1122 | 11 | 0011 | 1023 | 8 |
| 18 | 1111 | 0100 | 5 | 2011 | 0110 | 6 | 3101 | 0110 | 7 |
| 19 | 0111 | 1011 | 6 | 0012 | 3211 | 10 | 1122 | 2111 | 11 |
| 20 | 0234 | 4314 | 21 | 1111 | 1112 | 9 | 0113 | 3344 | 19 |
| 21 | 2322 | 3242 | 20 | 2102 | 2211 | 11 | 3112 | 2224 | 17 |
| 22 | 1111 | 0210 | 7 | 0111 | 2221 | 10 | 3222 | 3343 | 22 |
| 23 | 1112 | 1112 | 10 | 0111 | 1010 | 5 | 3433 | 2234 | 24 |
| 24 | 0111 | 2101 | 7 | 0101 | 0110 | 4 | 4332 | 2322 | 21 |
| 25 | 0001 | 1110 | 4 | 2112 | 3232 | 16 | 3211 | 1332 | 16 |
| 26 | 0001 | 2433 | 13 | 2222 | 3443 | 22 | 1122 | 0021 | 9 |
| 27 | 3322 | 3211 | 17 | 3232 | 2353 | 23 | 0003 | 2554 | 19 |
| 28 | 1111 | 1113 | 10 | 3223 | 2222 | 18 | 4342 | 2355 | 28 |
| 29 | 4423 | 3334 | 26 | 2111 | 2132 | 13 | 4444 | 4344 | 31 |
| 30 | 3232 | 2321 | 18 | 1211 | 1021 | 9 | 3332 | 2242 | 21 |
| 31 | 1122 | 3212 | 14 | 1112 | 1233 | 14 | | | |

Three-hour-range K indices
Belsk, October - December, 2007
The limit of K=9 is 450

| Day | October | | | November | | | December | | |
|-----|---------|------|----|----------|------|----|----------|------|----|
| | K | SK | | K | SK | | K | SK | |
| 1 | 3222 | 2323 | 19 | 3111 | 1121 | 11 | 3111 | 1011 | 9 |
| 2 | 1111 | 0024 | 10 | 1111 | 1011 | 7 | 0111 | 0110 | 5 |
| 3 | 4332 | 4343 | 26 | 0001 | 1110 | 4 | 0000 | 0000 | 0 |
| 4 | 3223 | 2330 | 18 | 1000 | 1431 | 10 | 1001 | 1111 | 6 |
| 5 | 1212 | 2131 | 13 | 1111 | 0001 | 5 | 2111 | 1000 | 6 |
| 6 | 1011 | 1112 | 8 | 0000 | 1100 | 2 | 0111 | 2122 | 10 |
| 7 | 1111 | 1101 | 7 | 0001 | 0001 | 2 | 1110 | 0020 | 5 |
| 8 | 0010 | 0012 | 4 | 1110 | 1112 | 8 | 0000 | 0002 | 2 |
| 9 | 0111 | 0010 | 4 | 2111 | 2213 | 13 | 2101 | 1231 | 11 |
| 10 | 0110 | 0000 | 2 | 3011 | 2210 | 10 | 0111 | 2225 | 14 |
| 11 | 0000 | 0012 | 3 | 2111 | 1111 | 9 | 3322 | 3444 | 25 |
| 12 | 0112 | 1223 | 12 | 0011 | 1232 | 10 | 3233 | 2113 | 18 |
| 13 | 0011 | 1012 | 6 | 3222 | 3134 | 20 | 2211 | 1130 | 11 |
| 14 | 2122 | 1211 | 12 | 3222 | 3322 | 19 | 1212 | 1121 | 11 |
| 15 | 2111 | 1111 | 9 | 2111 | 3233 | 16 | 1111 | 1201 | 8 |
| 16 | 0001 | 1210 | 5 | 1112 | 2333 | 16 | 1110 | 0113 | 8 |
| 17 | 1000 | 0010 | 2 | 4221 | 1320 | 15 | 2233 | 4434 | 25 |
| 18 | 1223 | 2233 | 18 | 1111 | 1200 | 7 | 4333 | 3444 | 28 |
| 19 | 3323 | 4343 | 25 | 1010 | 0023 | 7 | 3222 | 3133 | 19 |
| 20 | 3332 | 1331 | 19 | 3224 | 6544 | 30 | 3222 | 3543 | 24 |
| 21 | 1121 | 1132 | 12 | 3324 | 3322 | 22 | 3222 | 3442 | 22 |
| 22 | 2111 | 1242 | 14 | 1211 | 1443 | 17 | 1211 | 3342 | 17 |
| 23 | 3212 | 2131 | 15 | 4322 | 3232 | 21 | 2222 | 3323 | 19 |
| 24 | 1001 | 1221 | 8 | 2222 | 2543 | 22 | 1111 | 0122 | 9 |
| 25 | 1013 | 3454 | 21 | 2233 | 3443 | 24 | 1010 | 1100 | 4 |
| 26 | 2222 | 3442 | 21 | 3223 | 2122 | 17 | 1011 | 1112 | 8 |
| 27 | 2323 | 3423 | 22 | 1211 | 1222 | 12 | 1211 | 0123 | 11 |
| 28 | 2212 | 3421 | 17 | 2111 | 1312 | 12 | 3211 | 1120 | 11 |
| 29 | 2111 | 3355 | 21 | 0001 | 1321 | 8 | 0001 | 1112 | 6 |
| 30 | 3321 | 2322 | 18 | 0011 | 1222 | 9 | 1101 | 1110 | 6 |
| 31 | 2111 | 2231 | 13 | | | | 0001 | 2132 | 9 |

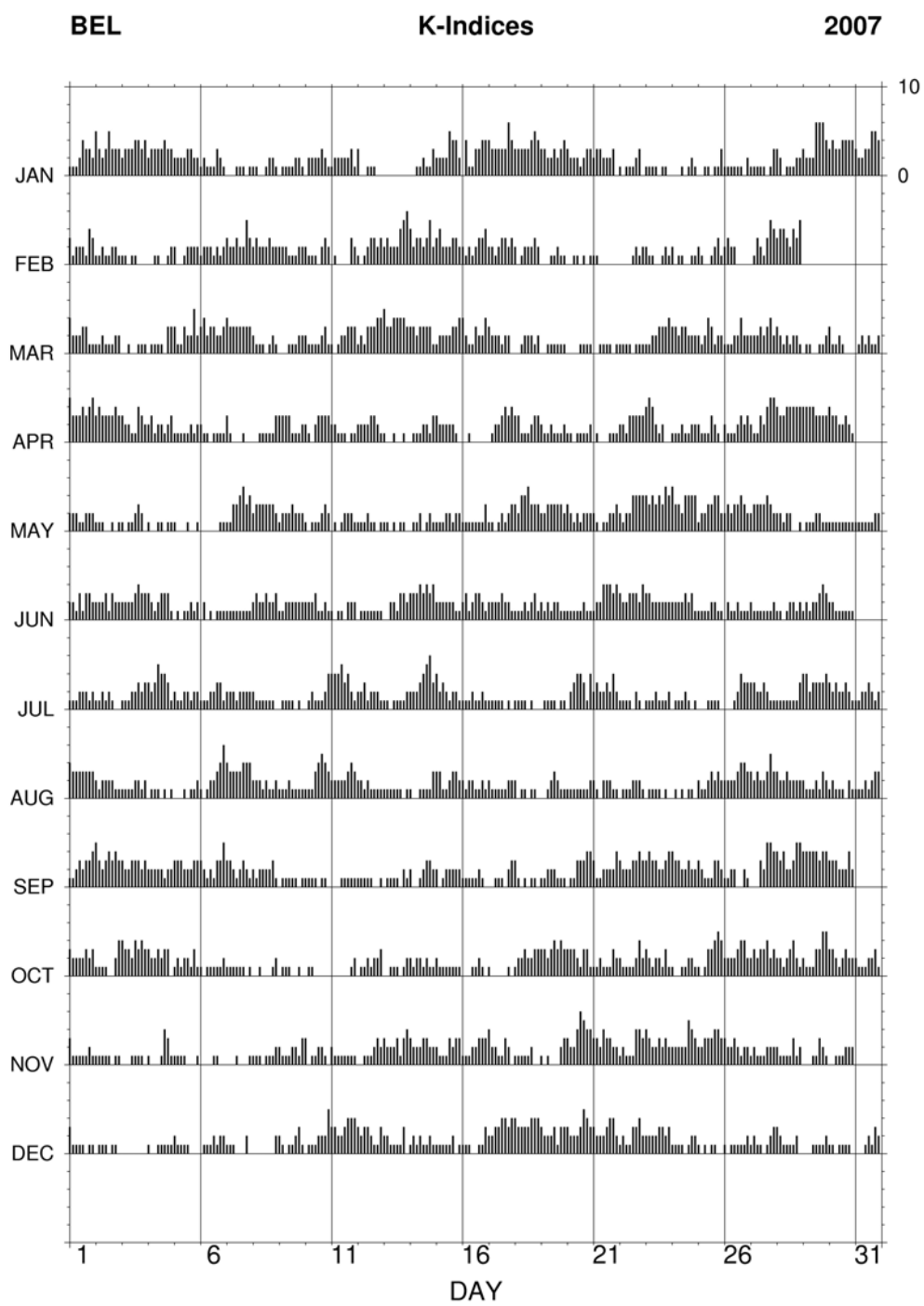

Fig. 11. K-indices in graphical form, Belsk 2007.

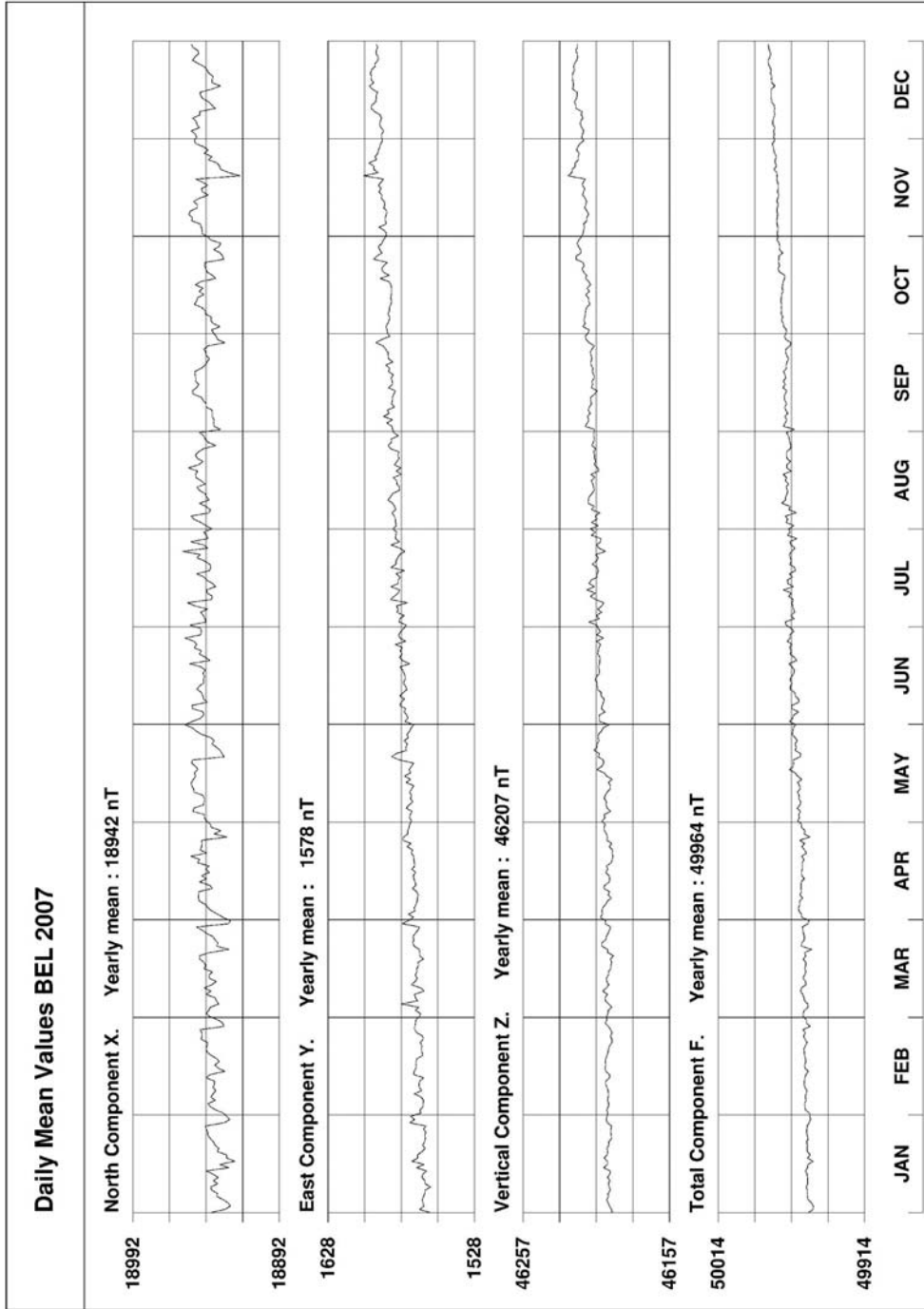

Fig. 12. Daily mean data plot for Belsk 2007.

BEL - Hourly Mean Values

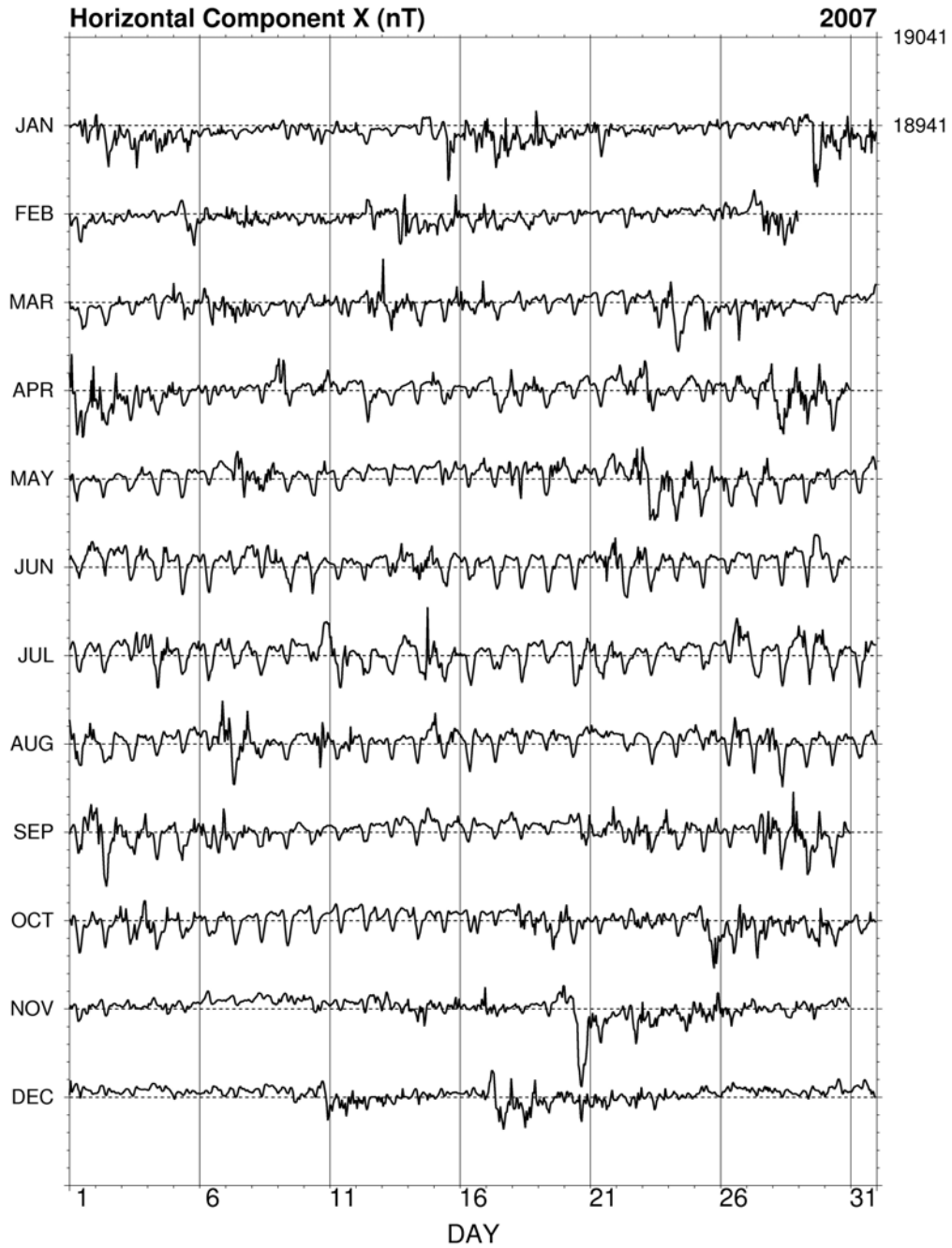

Fig. 13. Hourly mean data plot of X component for Belsk 2007.

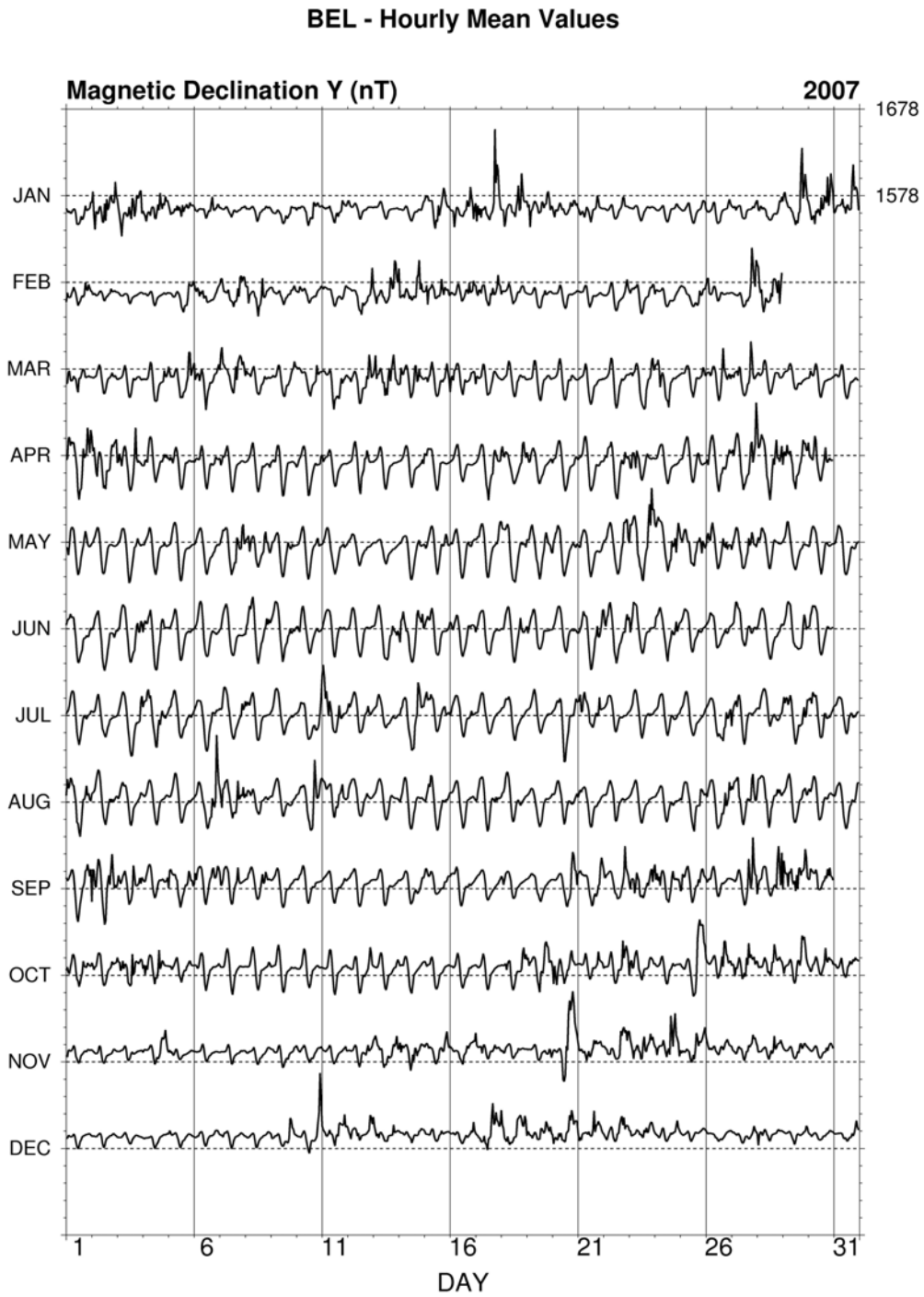

Fig. 14. Hourly mean data plot of Y component for Belsk 2007.

BEL - Hourly Mean Values

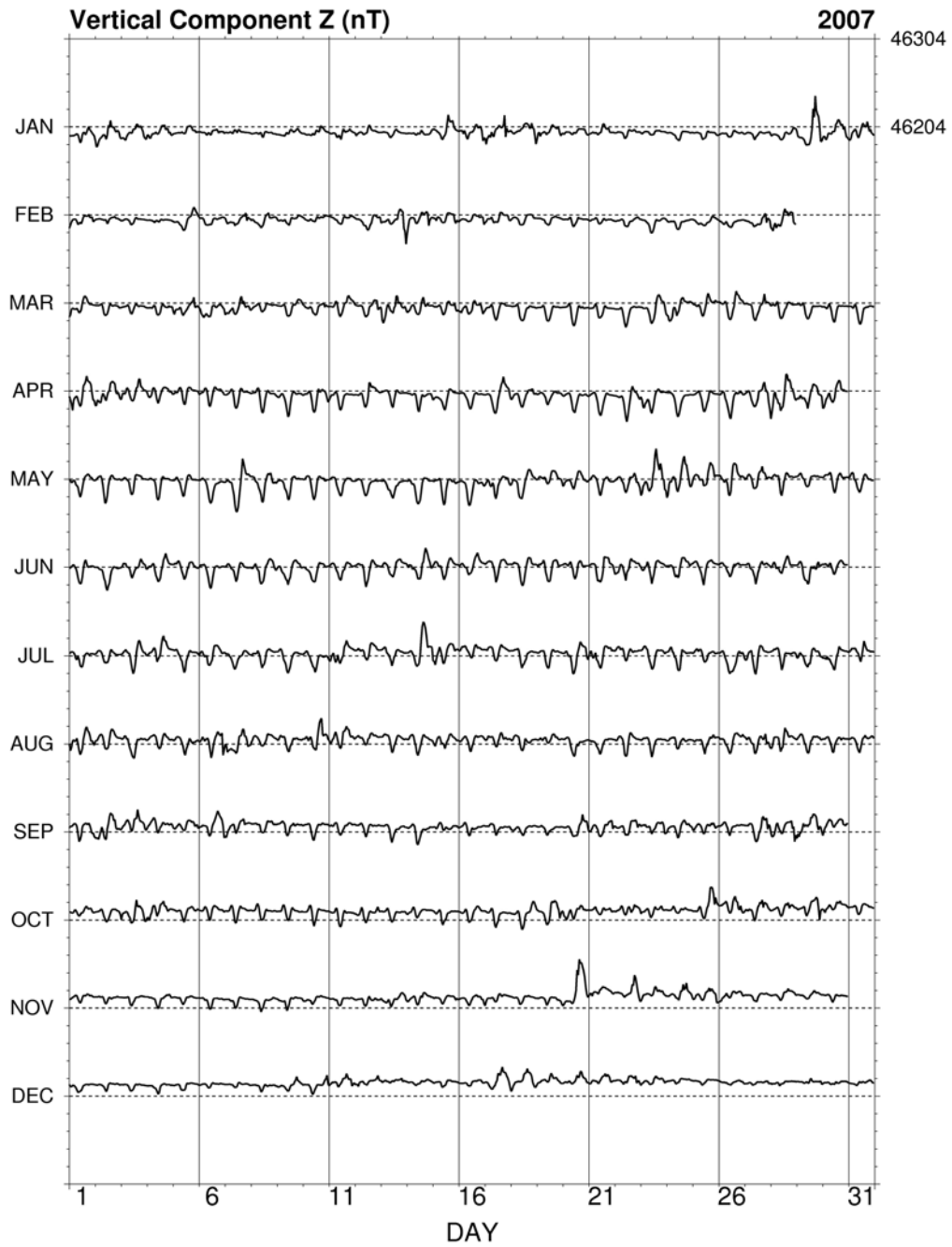

Fig. 15. Hourly mean data plot of Z component for Belsk 2007.

BEL - Hourly Mean Values

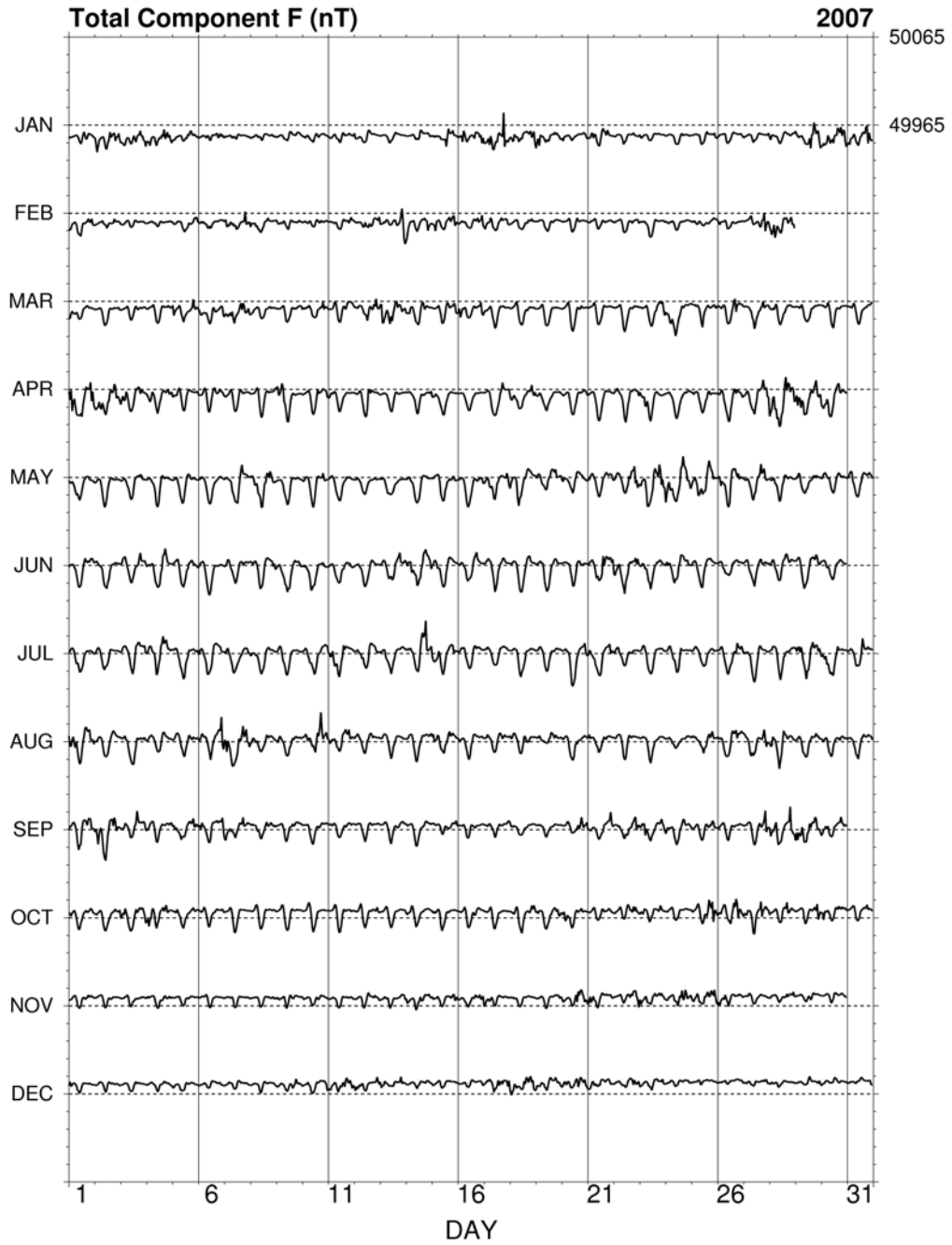

Fig. 16. Hourly mean data plot of F component for Belsk 2007.

Tables and plots for Hel Observatory

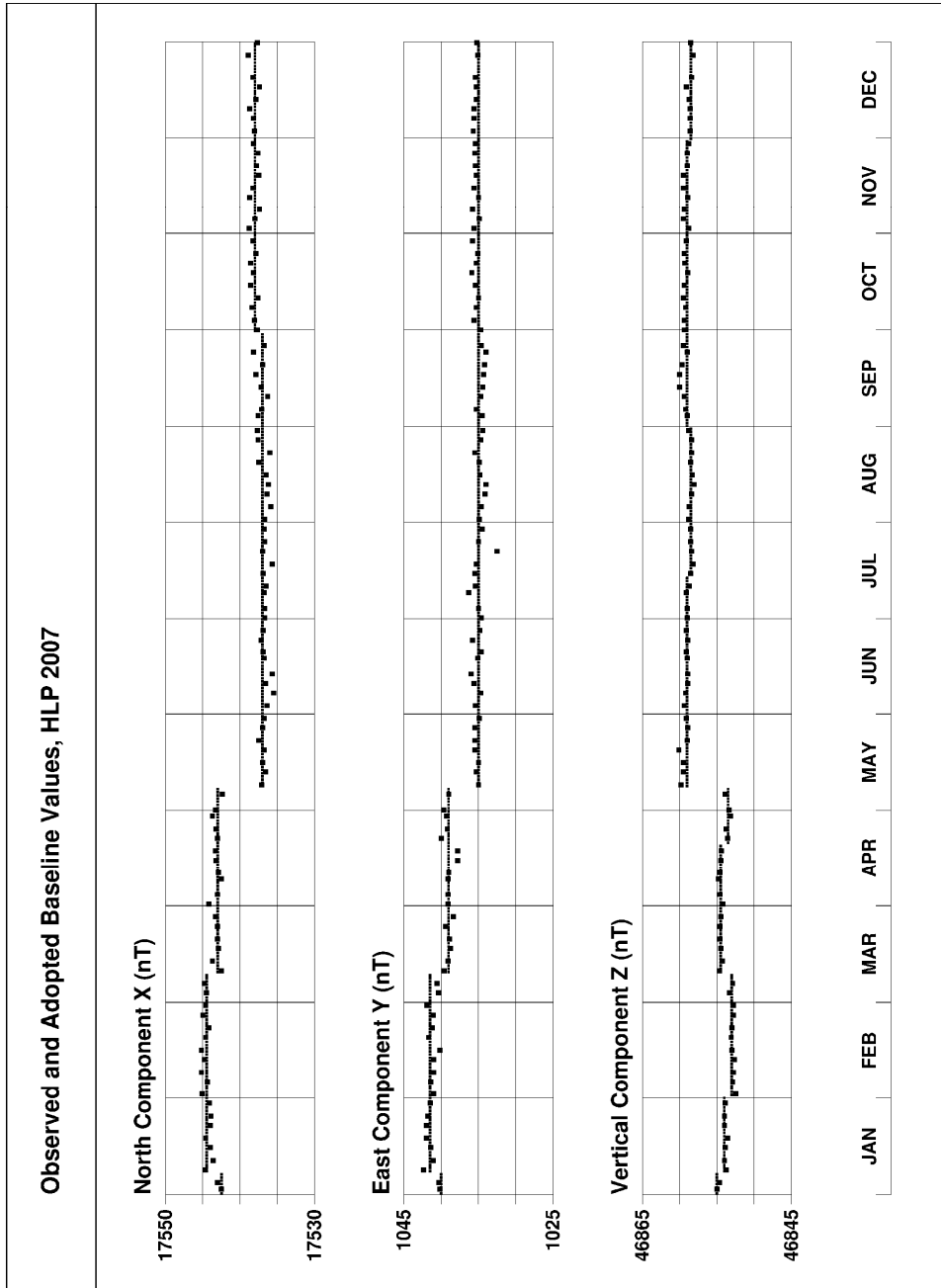

Fig. 17. Base values of set 1, Hel 2007.

Annual mean values of magnetic elements in Hel Observatory

| No | Year | D [° '] | H [nT] | Z [nT] | X [nT] | Y [nT] | I [° '] | F [nT] |
|----|------|--------------|-------------|-------------|-------------|-------------|--------------|-------------|
| 1 | 1953 | -0 14.5 | 17388 | 45327 | 17388 | -73 | 69 00.8 | 48548 |
| 2 | 1954 | -0 10.0 | 17394 | 45374 | 17394 | -51 | 69 01.5 | 48594 |
| 3 | 1955 | -0 04.2 | 17379 | 45430 | 17379 | -21 | 69 03.9 | 48640 |
| 4 | 1956 | 0 03.9 | 17371 | 45450 | 17371 | 20 | 69 05.0 | 48656 |
| 5 | 1957 | 0 05.7 | 17372 | 45475 | 17372 | 29 | 69 05.5 | 48680 |
| 6 | 1958 | 0 10.2 | 17380 | 45535 | 17380 | 52 | 69 06.5 | 48739 |
| 7 | 1959 | 0 14.7 | 17390 | 45565 | 17390 | 74 | 69 06.6 | 48771 |
| 8 | 1960 | 0 17.6 | 17402 | 45602 | 17402 | 89 | 69 06.8 | 48810 |
| 9 | 1961 | 0 19.8 | 17422 | 45625 | 17422 | 100 | 69 06.0 | 48838 |
| 10 | 1962 | 0 22.7 | 17438 | 45647 | 17438 | 115 | 69 05.5 | 48864 |
| 11 | 1963 | 0 26.5 | 17449 | 45663 | 17448 | 134 | 69 05.2 | 48883 |
| 12 | 1964 | 0 28.6 | 17464 | 45676 | 17463 | 145 | 69 04.6 | 48901 |
| 13 | 1965 | 0 30.0 | 17476 | 45692 | 17475 | 152 | 69 04.2 | 48920 |
| 14 | 1966 | 0 31.6 | 17485 | 45710 | 17484 | 161 | 69 04.0 | 48940 |
| 15 | 1967 | 0 33.3 | 17492 | 45743 | 17491 | 169 | 69 04.4 | 48973 |
| 16 | 1968 | 0 34.4 | 17502 | 45769 | 17501 | 175 | 69 04.4 | 49001 |
| 17 | 1969 | 0 34.3 | 17524 | 45792 | 17523 | 175 | 69 03.5 | 49030 |
| 18 | 1970 | 0 34.8 | 17542 | 45824 | 17541 | 178 | 69 03.2 | 49067 |
| 19 | 1971 | 0 35.7 | 17565 | 45849 | 17564 | 182 | 69 02.3 | 49098 |
| 20 | 1972 | 0 36.1 | 17579 | 45880 | 17578 | 184 | 69 02.1 | 49132 |
| 21 | 1973 | 0 38.5 | 17595 | 45912 | 17594 | 197 | 69 01.9 | 49168 |
| 22 | 1974 | 0 41.9 | 17606 | 45951 | 17605 | 215 | 69 02.2 | 49208 |
| 23 | 1975 | 0 45.0 | 17625 | 45984 | 17623 | 231 | 69 01.7 | 49246 |
| 24 | 1976 | 0 49.6 | 17639 | 46015 | 17637 | 254 | 69 01.6 | 49280 |
| 25 | 1977 | 0 55.0 | 17651 | 46045 | 17649 | 282 | 69 01.5 | 49312 |
| 26 | 1978 | 1 00.2 | 17646 | 46085 | 17643 | 309 | 69 02.9 | 49349 |
| 27 | 1979 | 1 05.1 | 17651 | 46112 | 17648 | 334 | 69 03.2 | 49375 |
| 28 | 1980 | 1 11.5 | 17653 | 46127 | 17649 | 367 | 69 03.5 | 49390 |
| 29 | 1981 | 1 17.5 | 17637 | 46156 | 17632 | 398 | 69 05.2 | 49411 |
| 30 | 1982 | 1 23.4 | 17620 | 46184 | 17615 | 427 | 69 07.1 | 49431 |
| 31 | 1983 | 1 28.6 | 17614 | 46200 | 17608 | 454 | 69 07.8 | 49444 |
| 32 | 1984 | 1 33.5 | 17602 | 46219 | 17596 | 479 | 69 09.1 | 49457 |
| 33 | 1985 | 1 37.9 | 17591 | 46239 | 17584 | 501 | 69 10.3 | 49472 |
| 34 | 1986 | 1 42.7 | 17579 | 46263 | 17571 | 525 | 69 11.6 | 49490 |
| 35 | 1987 | 1 46.3 | 17572 | 46285 | 17564 | 543 | 69 12.6 | 49508 |
| 36 | 1988 | 1 51.0 | 17555 | 46318 | 17546 | 567 | 69 14.6 | 49533 |
| 37 | 1989 | 1 55.5 | 17535 | 46352 | 17525 | 589 | 69 16.7 | 49558 |
| 38 | 1990 | 1 58.4 | 17527 | 46374 | 17516 | 604 | 69 17.8 | 49575 |
| 39 | 1991 | 2 00.6 | 17513 | 46398 | 17502 | 614 | 69 19.3 | 49593 |
| 40 | 1992 | 2 03.9 | 17515 | 46416 | 17504 | 631 | 69 19.6 | 49611 |
| 41 | 1993 | 2 10.0 | 17516 | 46428 | 17503 | 662 | 69 19.8 | 49622 |

| No | Year | D [° ´] | H [nT] | Z [nT] | X [nT] | Y [nT] | I [° ´] | F [nT] |
|----|--------|--------------|-------------|-------------|-------------|-------------|--------------|-------------|
| 42 | 1994 | 2 15.9 | 17512 | 46456 | 17498 | 692 | 69 20.7 | 49647 |
| 43 | 1995 | 2 21.3 | 17518 | 46481 | 17503 | 720 | 69 21.0 | 49672 |
| 44 | 1996 | 2 26.6 | 17523 | 46506 | 17507 | 747 | 69 21.2 | 49698 |
| 45 | 1997 | 2 32.9 | 17519 | 46539 | 17502 | 779 | 69 22.3 | 49727 |
| 46 | 1998 | 2 39.8 | 17512 | 46581 | 17493 | 814 | 69 23.8 | 49764 |
| 47 | 1999 | 2 45.4 | 17511 | 46615 | 17491 | 842 | 69 24.7 | 49796 |
| 48 | 2000 | 2 51.9 | 17507 | 46657 | 17485 | 875 | 69 25.9 | 49833 |
| 49 | 2001 | 2 57.7 | 17515 | 46692 | 17492 | 905 | 69 26.2 | 49869 |
| 50 | 2002 | 3 03.7 | 17520 | 46730 | 17495 | 936 | 69 26.9 | 49906 |
| 51 | 2003 | 3 10.8 | 17519 | 46777 | 17492 | 972 | 69 28.1 | 49950 |
| 52 | 2004 | 3 16.6 | 17529 | 46809 | 17500 | 1002 | 69 28.2 | 49983 |
| 53 | 2005 | 3 22.3 | 17531 | 46843 | 17501 | 1031 | 69 28.9 | 50016 |
| J | 2006.0 | 0 -1.5 | -2 | 9 | -2 | -8 | 0 0.6 | 7 |
| 54 | 2006 | 3 29.9 | 17550 | 46859 | 17517 | 1071 | 69 28.1 | 50038 |
| 55 | 2007 | 3 36.7 | 17559 | 46887 | 17524 | 1106 | 69 28.2 | 50067 |

Note: Since 2006 the observatory has stopped introducing the so-called historical corrections. The corrections were related, among other things, with the variable location of the instruments for absolute measurements. In the 2006.0 line we include the jump value J relating to the neglect of historical corrections. The jump values are defined as follows:

$$\text{jump value J} = \text{old site value} - \text{new site value}$$

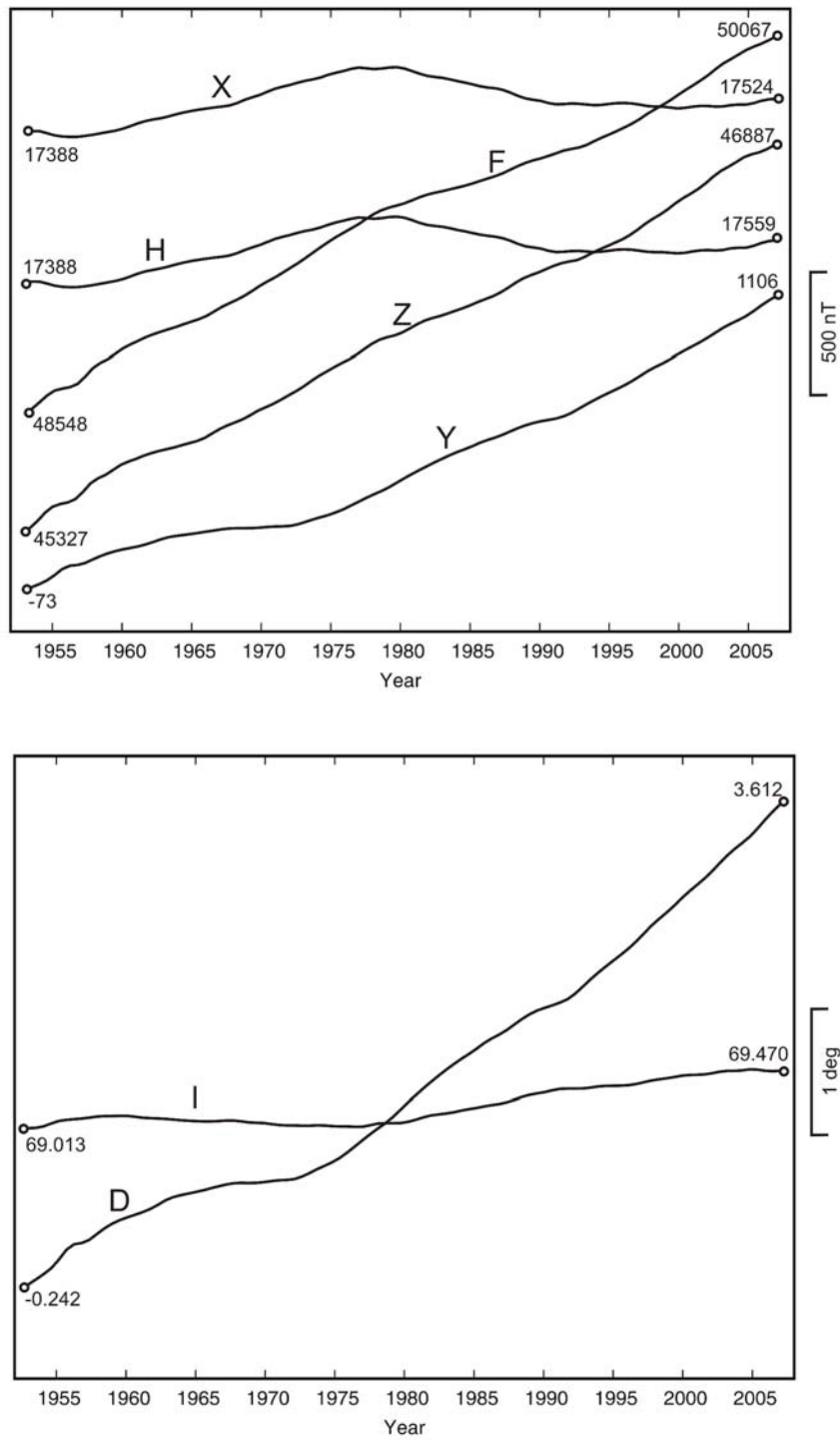

Fig. 18. Secular changes of H, X, Y, Z, F, D and I at Hel.

MONTHLY AND YEARLY MEAN VALUES OF MAGNETIC ELEMENTS

HEL. 2007

JAN FEB MAR APR MAY JUN JUL AUG SEP OCT NOV DEC MEAN

NORTH COMPONENT: 17000 + ... in nT

| | | | | | | | | | | | | | |
|----------------|-----|-----|-----|-----|-----|-----|-----|-----|-----|-----|-----|-----|-----|
| All days | 517 | 521 | 521 | 522 | 526 | 530 | 527 | 527 | 524 | 522 | 524 | 525 | 524 |
| Quiet days | 521 | 525 | 524 | 526 | 528 | 528 | 529 | 529 | 527 | 527 | 529 | 530 | 527 |
| Disturbed days | 510 | 517 | 517 | 514 | 522 | 532 | 526 | 528 | 519 | 515 | 512 | 517 | 519 |

EAST COMPONENT: 500 + ... in nT

| | | | | | | | | | | | | | |
|----------------|-----|-----|-----|-----|-----|-----|-----|-----|-----|-----|-----|-----|-----|
| All days | 594 | 596 | 596 | 598 | 600 | 602 | 606 | 609 | 613 | 616 | 621 | 624 | 606 |
| Quiet days | 592 | 594 | 595 | 597 | 598 | 602 | 607 | 608 | 610 | 614 | 617 | 621 | 605 |
| Disturbed days | 598 | 599 | 599 | 603 | 604 | 602 | 606 | 610 | 616 | 620 | 626 | 627 | 609 |

VERTICAL COMPONENT: 46500 + ... in nT

| | | | | | | | | | | | | | |
|----------------|-----|-----|-----|-----|-----|-----|-----|-----|-----|-----|-----|-----|-----|
| All days | 379 | 379 | 380 | 381 | 383 | 385 | 387 | 388 | 391 | 396 | 399 | 401 | 387 |
| Quiet days | 378 | 378 | 379 | 380 | 380 | 384 | 386 | 388 | 391 | 394 | 396 | 399 | 386 |
| Disturbed days | 380 | 378 | 378 | 380 | 385 | 385 | 389 | 387 | 389 | 399 | 405 | 404 | 388 |

Three-hour-range K indices

Hel, January - March, 2007

The limit of K=9 is 550

| Day | January | | | February | | | March | | |
|-----|---------|------|----|----------|------|----|-------|------|----|
| | K | SK | | K | SK | | K | SK | |
| 1 | 1102 | 3332 | 15 | 3122 | 1133 | 16 | 4222 | 3311 | 18 |
| 2 | 4323 | 4334 | 26 | 1122 | 1221 | 12 | 0021 | 1122 | 9 |
| 3 | 2333 | 4433 | 25 | 1101 | 0000 | 3 | 0000 | 0101 | 2 |
| 4 | 2333 | 3432 | 23 | 0001 | 0001 | 2 | 0011 | 1022 | 7 |
| 5 | 2222 | 3222 | 17 | 2001 | 2222 | 11 | 3013 | 2153 | 18 |
| 6 | 1210 | 1321 | 11 | 1222 | 0111 | 10 | 3423 | 3213 | 21 |
| 7 | 0000 | 1000 | 1 | 3123 | 2253 | 21 | 4233 | 3333 | 24 |
| 8 | 1001 | 0221 | 7 | 2321 | 2321 | 16 | 2110 | 0120 | 7 |
| 9 | 0010 | 1121 | 6 | 2221 | 0122 | 12 | 0001 | 1122 | 7 |
| 10 | 0211 | 1311 | 10 | 1000 | 0231 | 7 | 1011 | 1231 | 10 |
| 11 | 1122 | 2121 | 12 | 0000 | 0022 | 4 | 1012 | 2323 | 14 |
| 12 | 3001 | 0000 | 4 | 0002 | 3323 | 13 | 1223 | 3233 | 19 |
| 13 | 0000 | 0000 | 0 | 2322 | 1355 | 23 | 4334 | 4443 | 29 |
| 14 | 0011 | 2122 | 9 | 4233 | 2352 | 24 | 3323 | 3331 | 21 |
| 15 | 2122 | 5341 | 20 | 3423 | 2332 | 22 | 1122 | 3334 | 19 |
| 16 | 0411 | 2334 | 18 | 2111 | 2233 | 15 | 4211 | 3124 | 18 |
| 17 | 4333 | 3353 | 27 | 2212 | 3223 | 17 | 3222 | 2220 | 15 |
| 18 | 2333 | 3444 | 26 | 1012 | 1232 | 12 | 0011 | 2211 | 8 |
| 19 | 2322 | 3224 | 20 | 0001 | 1201 | 5 | 0001 | 1101 | 4 |
| 20 | 2222 | 1223 | 16 | 0001 | 0100 | 2 | 0000 | 1011 | 3 |
| 21 | 2222 | 1230 | 14 | 1000 | 0000 | 1 | 0011 | 1100 | 4 |
| 22 | 1011 | 1130 | 8 | 0000 | 1112 | 5 | 1011 | 0101 | 5 |
| 23 | 1211 | 0100 | 6 | 2100 | 0021 | 6 | 1113 | 3324 | 18 |
| 24 | 0000 | 0110 | 2 | 2000 | 0010 | 3 | 3323 | 3222 | 20 |
| 25 | 0011 | 0112 | 6 | 1000 | 1121 | 6 | 2123 | 3122 | 16 |
| 26 | 1011 | 1101 | 6 | 2322 | 1000 | 10 | 1112 | 2422 | 15 |
| 27 | 1100 | 1013 | 7 | 0032 | 1344 | 17 | 2223 | 2242 | 19 |
| 28 | 3101 | 0122 | 10 | 3433 | 2434 | 26 | 3222 | 1221 | 15 |
| 29 | 3222 | 5564 | 29 | | | | 0101 | 1112 | 7 |
| 30 | 3433 | 4344 | 28 | | | | 3112 | 1000 | 8 |
| 31 | 3223 | 3553 | 26 | | | | 0121 | 2112 | 10 |

Three-hour-range K indices

Hel, April - June, 2007

The limit of K=9 is 550

| Day | April | | | May | | | June | | |
|-----|-------|------|----|------|------|----|------|------|----|
| | K | SK | | K | SK | | K | SK | |
| 1 | 4433 | 4335 | 29 | 2221 | 2221 | 14 | 2113 | 1232 | 15 |
| 2 | 3433 | 3343 | 26 | 1100 | 1101 | 5 | 2222 | 1322 | 16 |
| 3 | 3221 | 2422 | 18 | 1011 | 2321 | 11 | 2222 | 3433 | 21 |
| 4 | 3222 | 2223 | 18 | 1001 | 1010 | 4 | 3212 | 3331 | 18 |
| 5 | 1111 | 1102 | 8 | 1000 | 0001 | 2 | 0001 | 1211 | 6 |
| 6 | 2110 | 1111 | 8 | 0000 | 0001 | 1 | 0101 | 1101 | 5 |
| 7 | 3100 | 1100 | 6 | 1033 | 4534 | 23 | 1101 | 1111 | 7 |
| 8 | 0011 | 1102 | 6 | 2333 | 3332 | 22 | 2222 | 3223 | 18 |
| 9 | 3233 | 1112 | 16 | 1222 | 3212 | 15 | 1122 | 2222 | 14 |
| 10 | 2102 | 3333 | 17 | 0000 | 1231 | 7 | 2122 | 2121 | 13 |
| 11 | 2211 | 1001 | 8 | 0001 | 2121 | 7 | 1001 | 0211 | 6 |
| 12 | 2222 | 4321 | 18 | 1102 | 0100 | 5 | 0001 | 1011 | 4 |
| 13 | 1011 | 0000 | 3 | 1101 | 0100 | 4 | 1022 | 2332 | 15 |
| 14 | 0111 | 2213 | 11 | 0002 | 0220 | 6 | 3234 | 3434 | 26 |
| 15 | 2122 | 2100 | 10 | 1012 | 2111 | 9 | 2222 | 2211 | 14 |
| 16 | 0000 | 1000 | 1 | 1101 | 1112 | 8 | 2211 | 3211 | 13 |
| 17 | 0122 | 4334 | 19 | 1111 | 2113 | 11 | 2122 | 3221 | 15 |
| 18 | 2212 | 1233 | 16 | 3234 | 5323 | 25 | 1112 | 1321 | 12 |
| 19 | 2111 | 2112 | 11 | 2233 | 3332 | 21 | 2111 | 2211 | 11 |
| 20 | 1000 | 1102 | 5 | 3213 | 1122 | 15 | 1111 | 1201 | 8 |
| 21 | 0100 | 1011 | 4 | 2101 | 1223 | 12 | 0124 | 4434 | 22 |
| 22 | 2213 | 3333 | 20 | 1122 | 4444 | 22 | 3223 | 3324 | 22 |
| 23 | 3442 | 1200 | 16 | 4343 | 4354 | 30 | 2322 | 2122 | 16 |
| 24 | 1111 | 1222 | 11 | 5333 | 4444 | 30 | 2212 | 3231 | 16 |
| 25 | 2111 | 3210 | 11 | 1223 | 3442 | 21 | 1001 | 2211 | 8 |
| 26 | 2112 | 2322 | 15 | 2323 | 3432 | 22 | 0112 | 2111 | 9 |
| 27 | 2113 | 3345 | 22 | 2223 | 3432 | 21 | 2111 | 1112 | 10 |
| 28 | 4334 | 4444 | 30 | 2212 | 2001 | 10 | 1001 | 2212 | 9 |
| 29 | 3343 | 3333 | 25 | 0001 | 2211 | 7 | 1212 | 2333 | 17 |
| 30 | 4332 | 3321 | 21 | 1101 | 1100 | 5 | 2211 | 1110 | 9 |
| 31 | | | | 1111 | 1122 | 10 | | | |

Three-hour-range K indices
Hel, July - September, 2007
The limit of K=9 is 550

| Day | July | | | August | | | September | | |
|-----|------|------|----|--------|------|----|-----------|------|----|
| | K | SK | | K | SK | | K | SK | |
| 1 | 1112 | 2212 | 12 | 4233 | 3333 | 24 | 1123 | 2333 | 18 |
| 2 | 0121 | 2100 | 7 | 1122 | 2311 | 13 | 4323 | 4343 | 26 |
| 3 | 1112 | 2323 | 15 | 1111 | 2211 | 10 | 3223 | 3323 | 21 |
| 4 | 3235 | 4431 | 25 | 0001 | 1101 | 4 | 2222 | 2122 | 15 |
| 5 | 2112 | 2122 | 13 | 0001 | 1112 | 6 | 3333 | 2232 | 21 |
| 6 | 1112 | 2231 | 13 | 1012 | 2346 | 19 | 2312 | 1334 | 19 |
| 7 | 2111 | 2222 | 13 | 4333 | 3444 | 28 | 3322 | 2321 | 18 |
| 8 | 2211 | 1110 | 9 | 2221 | 2111 | 12 | 2122 | 2321 | 15 |
| 9 | 0101 | 1010 | 4 | 1111 | 1111 | 8 | 0011 | 1101 | 5 |
| 10 | 0121 | 1024 | 11 | 1113 | 5543 | 23 | 0011 | 1110 | 5 |
| 11 | 3444 | 3421 | 25 | 2222 | 2343 | 20 | 0001 | 1111 | 5 |
| 12 | 2221 | 2211 | 13 | 2112 | 2111 | 11 | 1111 | 0001 | 5 |
| 13 | 0110 | 1113 | 8 | 1001 | 1001 | 4 | 0001 | 0021 | 4 |
| 14 | 1122 | 4453 | 22 | 1001 | 1113 | 8 | 1001 | 2232 | 11 |
| 15 | 3232 | 2221 | 17 | 3312 | 2322 | 18 | 2012 | 2222 | 13 |
| 16 | 1101 | 1121 | 8 | 2122 | 1121 | 12 | 1101 | 1110 | 6 |
| 17 | 1011 | 1010 | 5 | 2001 | 1121 | 8 | 0001 | 1022 | 6 |
| 18 | 1111 | 0100 | 5 | 1001 | 1010 | 4 | 2101 | 1000 | 5 |
| 19 | 0001 | 1101 | 4 | 0002 | 3200 | 7 | 1122 | 2110 | 10 |
| 20 | 0224 | 5324 | 22 | 1101 | 1111 | 7 | 0203 | 3343 | 18 |
| 21 | 2322 | 3242 | 20 | 2002 | 2211 | 10 | 2111 | 2224 | 15 |
| 22 | 1111 | 0210 | 7 | 0112 | 2210 | 9 | 3222 | 3343 | 22 |
| 23 | 1112 | 1112 | 10 | 0001 | 1110 | 4 | 2333 | 2233 | 21 |
| 24 | 0101 | 2101 | 6 | 0101 | 0110 | 4 | 3322 | 3322 | 20 |
| 25 | 0001 | 1110 | 4 | 3103 | 4232 | 18 | 3212 | 1232 | 16 |
| 26 | 0001 | 2433 | 13 | 1112 | 3443 | 19 | 1122 | 0011 | 8 |
| 27 | 3221 | 3201 | 14 | 3232 | 2343 | 22 | 0003 | 2543 | 17 |
| 28 | 0111 | 1113 | 9 | 2213 | 2122 | 15 | 4332 | 2355 | 27 |
| 29 | 4323 | 3334 | 25 | 2111 | 2122 | 12 | 4344 | 4343 | 29 |
| 30 | 2232 | 2321 | 17 | 1112 | 1021 | 9 | 3332 | 2232 | 20 |
| 31 | 1122 | 3212 | 14 | 1112 | 1233 | 14 | | | |

Three-hour-range K indices
Hel, October - December, 2007
The limit of K=9 is 550

| Day | October | | | November | | | December | | |
|-----|---------|------|----|----------|------|----|----------|------|----|
| | K | SK | | K | SK | | K | SK | |
| 1 | 2212 | 2222 | 15 | 3111 | 1121 | 11 | 3001 | 0000 | 4 |
| 2 | 1111 | 0024 | 10 | 1110 | 0001 | 4 | 0011 | 0110 | 4 |
| 3 | 3322 | 4343 | 24 | 0000 | 0000 | 0 | 0000 | 0000 | 0 |
| 4 | 3223 | 3330 | 19 | 1000 | 1331 | 9 | 1000 | 0001 | 2 |
| 5 | 1212 | 2121 | 12 | 0111 | 0002 | 5 | 2010 | 0000 | 3 |
| 6 | 1011 | 1012 | 7 | 0000 | 1000 | 1 | 0111 | 2021 | 8 |
| 7 | 0011 | 1001 | 4 | 0000 | 0001 | 1 | 0100 | 0010 | 2 |
| 8 | 0000 | 0012 | 3 | 1010 | 1112 | 7 | 0000 | 0001 | 1 |
| 9 | 0000 | 0010 | 1 | 2101 | 2112 | 10 | 2100 | 1131 | 9 |
| 10 | 0000 | 0000 | 0 | 2011 | 1200 | 7 | 0111 | 2225 | 14 |
| 11 | 0000 | 0011 | 2 | 1011 | 1011 | 6 | 3222 | 3443 | 23 |
| 12 | 0022 | 1123 | 11 | 0001 | 0232 | 8 | 2233 | 1113 | 16 |
| 13 | 0001 | 1011 | 4 | 3222 | 3124 | 19 | 2211 | 1130 | 11 |
| 14 | 1111 | 1101 | 7 | 3222 | 2322 | 18 | 0112 | 1121 | 9 |
| 15 | 2001 | 1010 | 5 | 2111 | 3233 | 16 | 1002 | 0100 | 4 |
| 16 | 0011 | 1210 | 6 | 1111 | 2233 | 14 | 1000 | 0113 | 6 |
| 17 | 1000 | 0010 | 2 | 3121 | 1320 | 13 | 2233 | 4434 | 25 |
| 18 | 1224 | 2233 | 19 | 1100 | 0100 | 3 | 3323 | 3444 | 26 |
| 19 | 2323 | 3343 | 23 | 1000 | 0023 | 6 | 2222 | 2133 | 17 |
| 20 | 3322 | 1331 | 18 | 3123 | 5544 | 27 | 2222 | 3543 | 23 |
| 21 | 1121 | 2132 | 13 | 3323 | 3322 | 21 | 3232 | 3442 | 23 |
| 22 | 2100 | 1232 | 11 | 0212 | 1443 | 17 | 1211 | 3342 | 17 |
| 23 | 3211 | 2121 | 13 | 4222 | 3232 | 20 | 2122 | 2223 | 16 |
| 24 | 1001 | 1210 | 6 | 2122 | 2443 | 20 | 1001 | 0122 | 7 |
| 25 | 1013 | 3454 | 21 | 2232 | 2433 | 21 | 0000 | 1000 | 1 |
| 26 | 2222 | 3442 | 21 | 3223 | 1122 | 16 | 1000 | 0001 | 2 |
| 27 | 2323 | 3423 | 22 | 1211 | 1222 | 12 | 1111 | 1123 | 11 |
| 28 | 2112 | 2421 | 15 | 1011 | 1312 | 10 | 3111 | 1111 | 10 |
| 29 | 2111 | 3355 | 21 | 0001 | 1210 | 5 | 0000 | 0012 | 3 |
| 30 | 3222 | 1321 | 16 | 0011 | 1221 | 8 | 1000 | 1110 | 4 |
| 31 | 2111 | 2231 | 13 | | | | 0001 | 2232 | 10 |

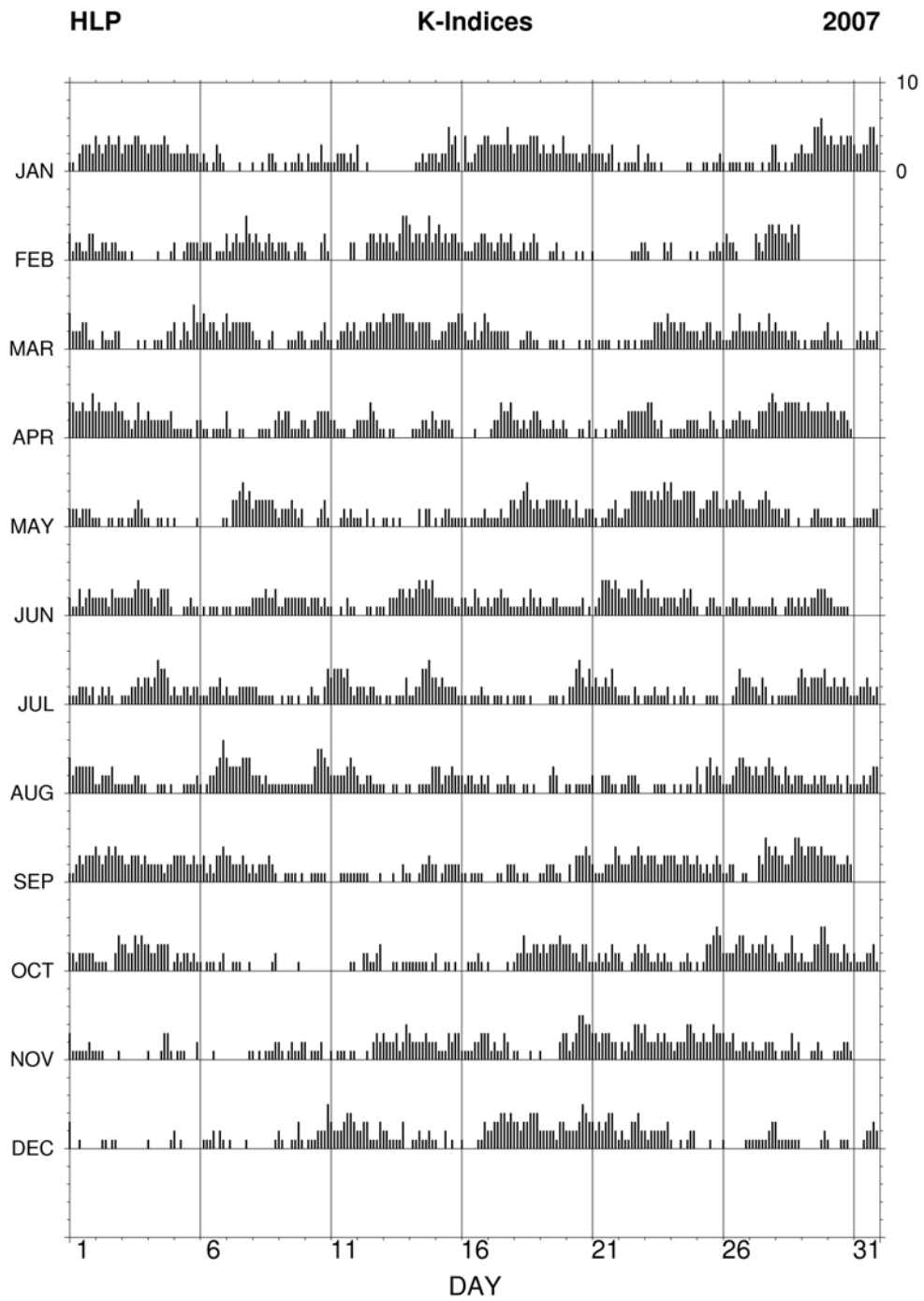

Fig. 19. K-indices in graphical form, Hel 2007.

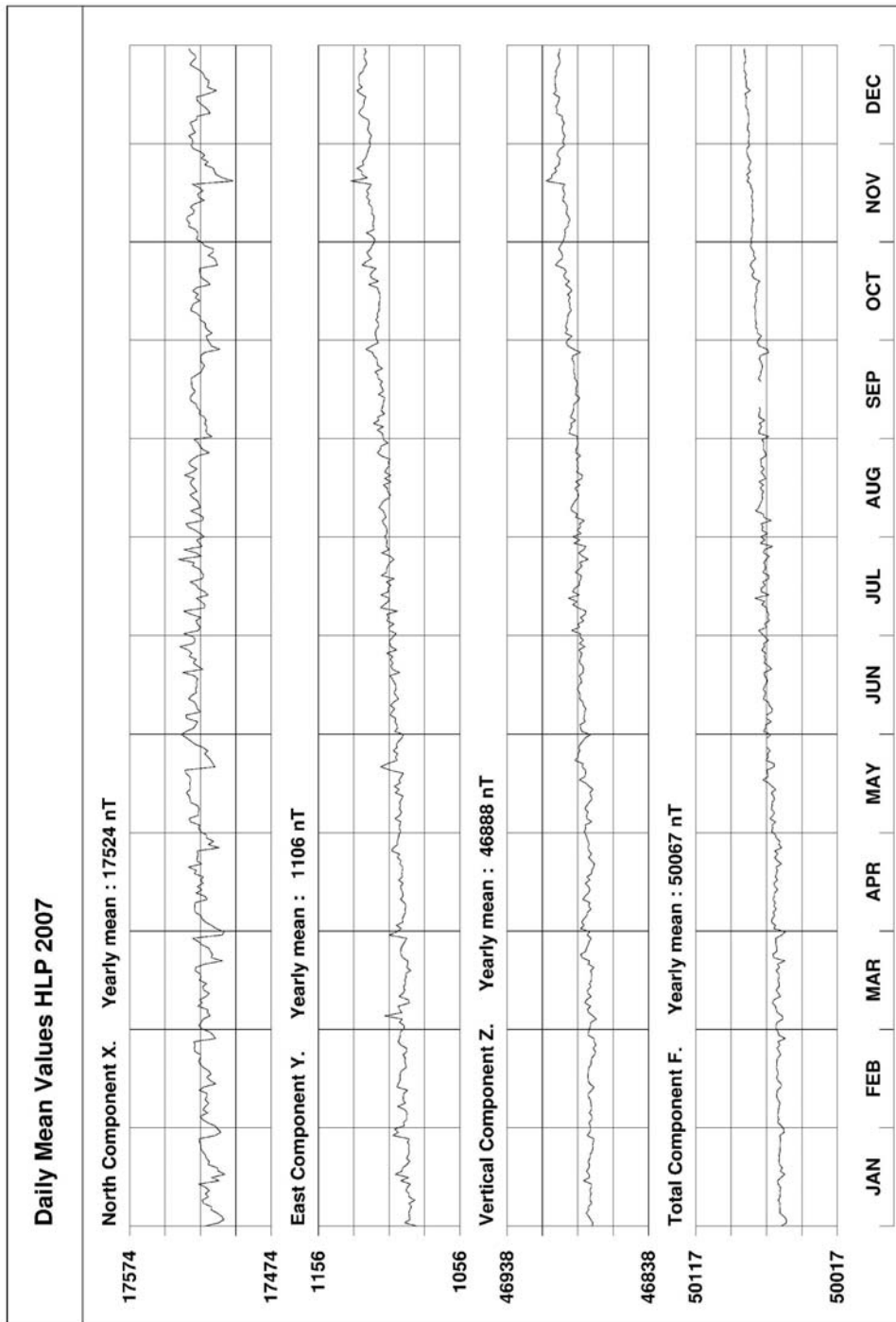

Fig. 20. Daily mean data plot for Hel 2007.

HLP - Hourly Mean Values

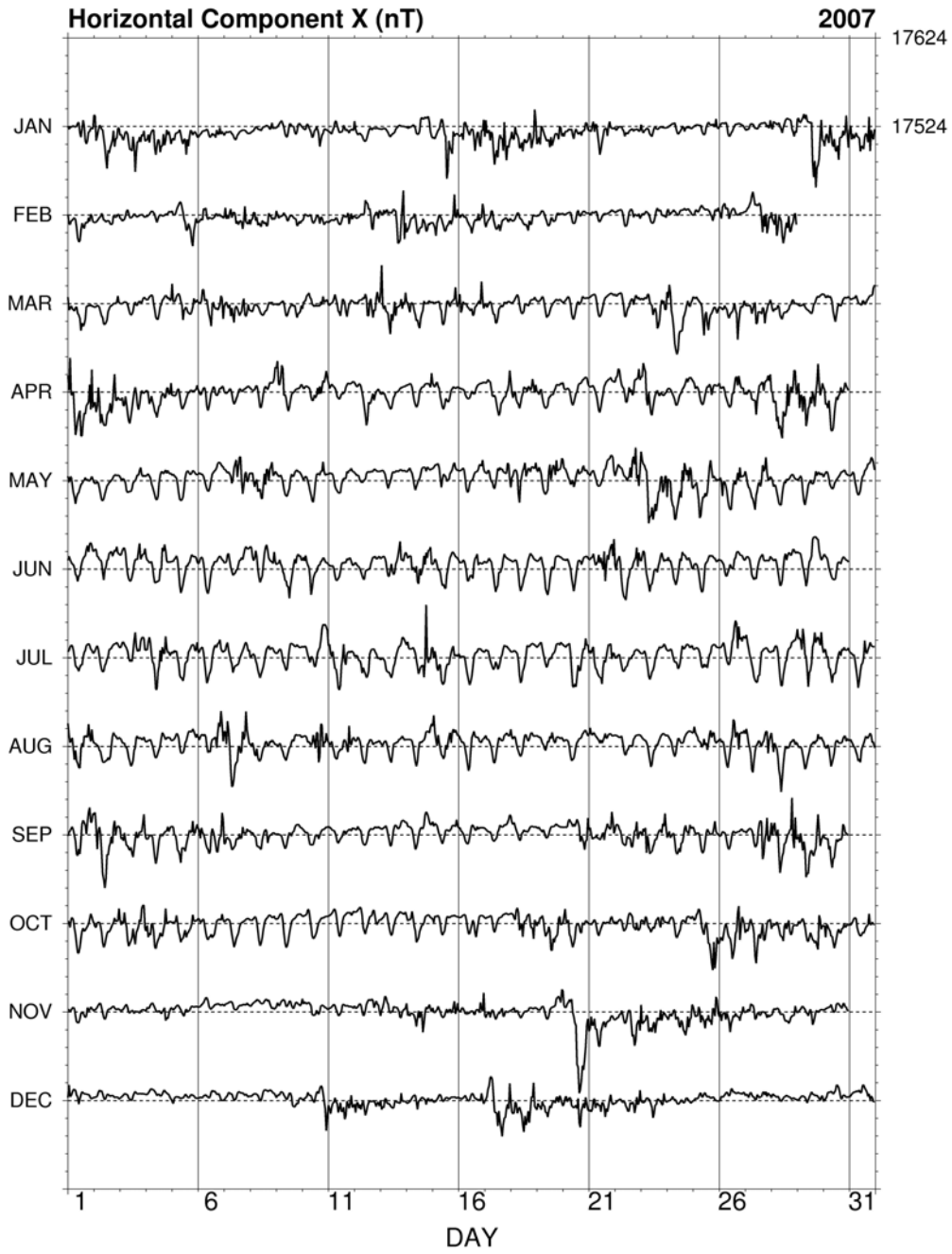

Fig. 21. Hourly mean data plot of X component for Hel 2007.

HLP - Hourly Mean Values

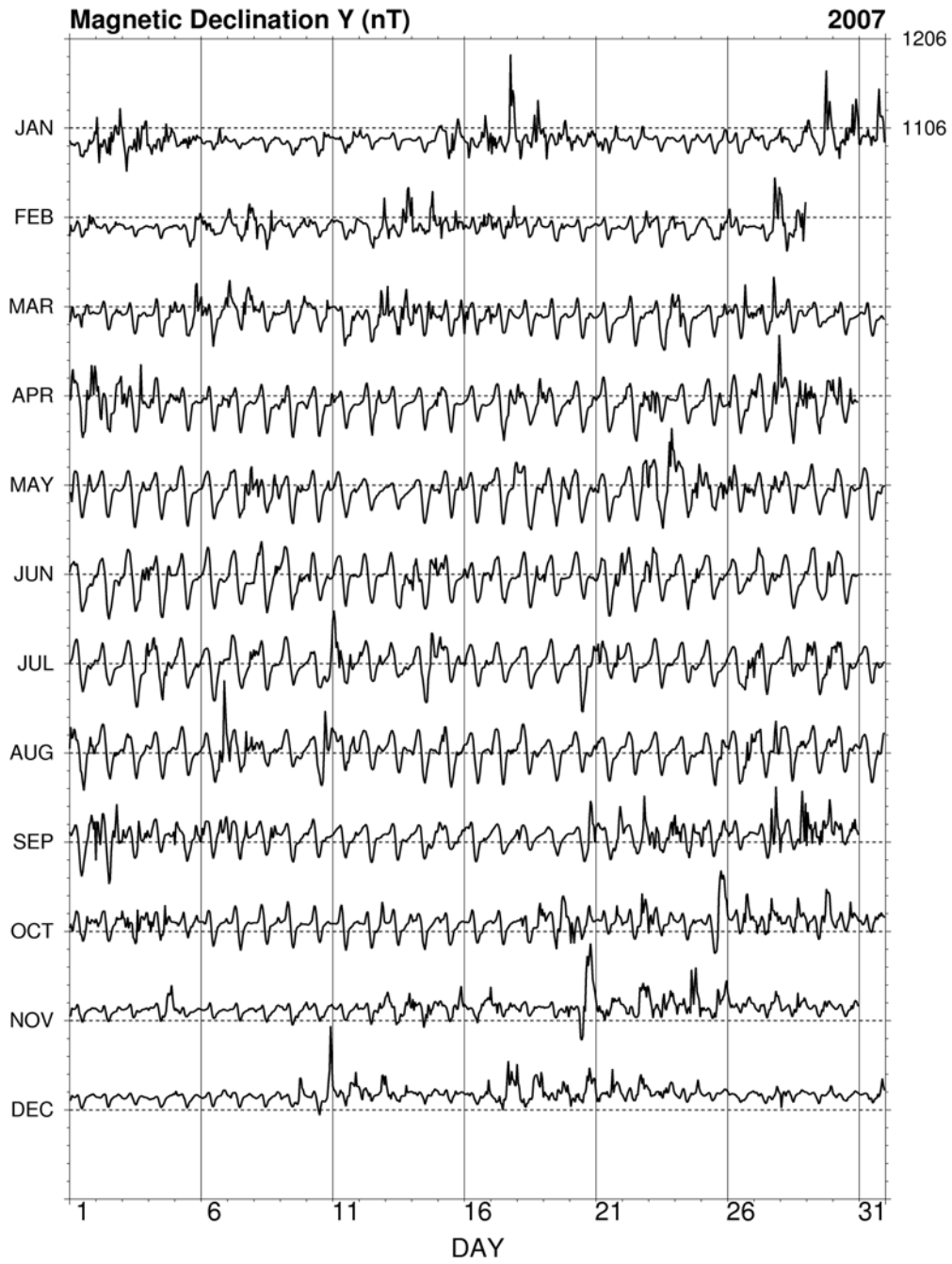

Fig. 22. Hourly mean data plot of Y component for Hel 2007.

HLP - Hourly Mean Values

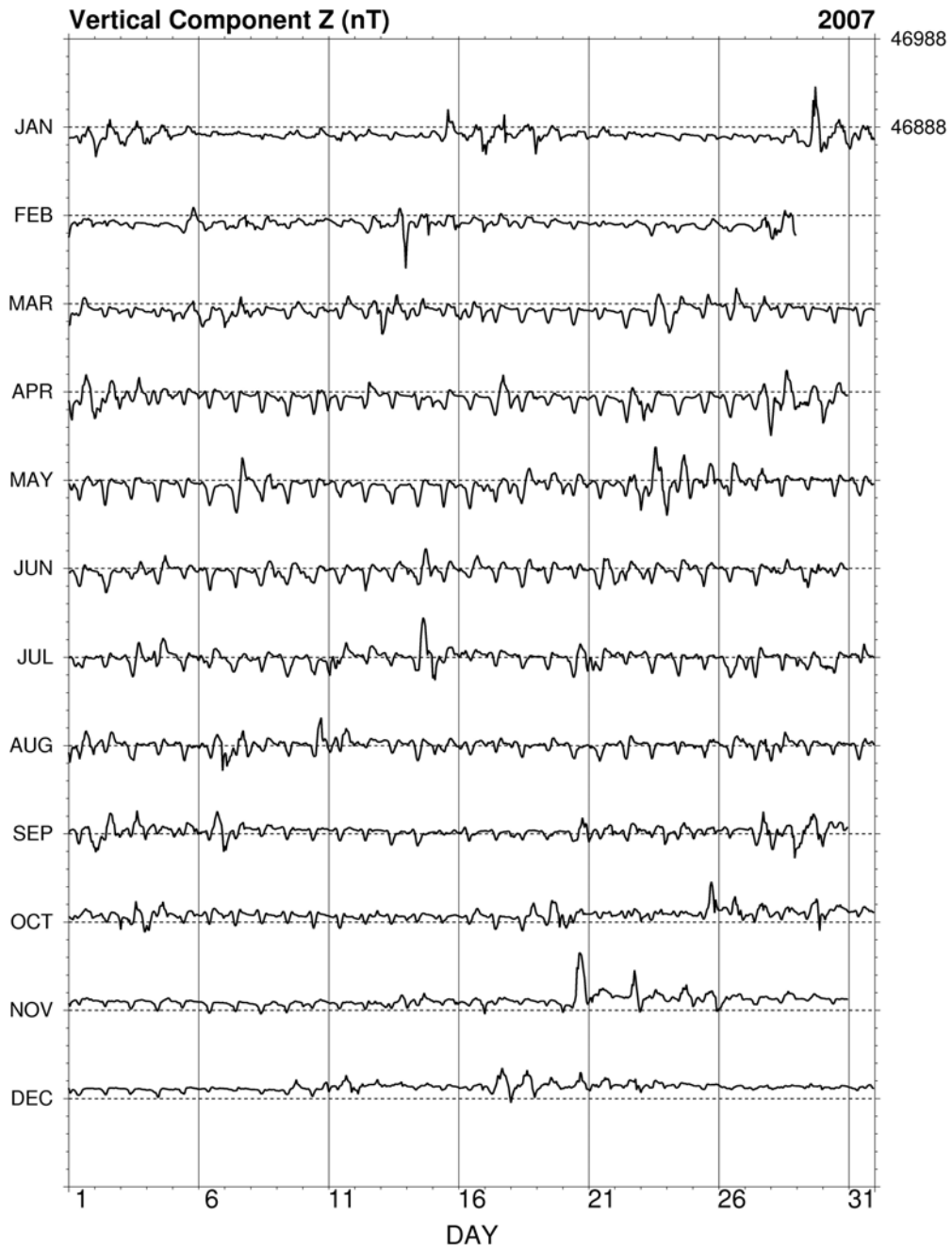

Fig. 23. Hourly mean data plot of Z component for Hel 2007.

HLP - Hourly Mean Values

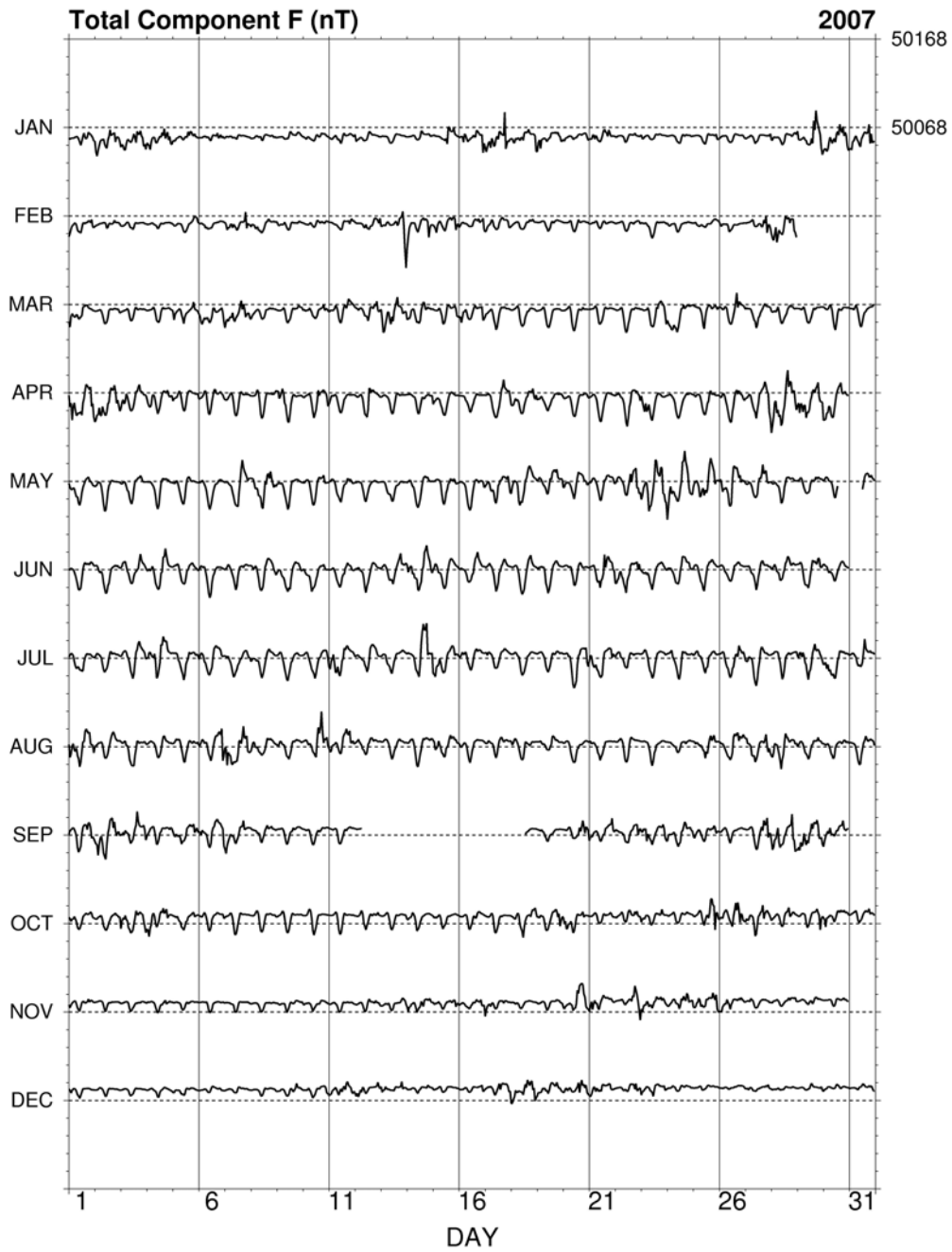

Fig. 24. Hourly mean data plot of F component for Hel 2007.

Tables and plots for Hornsund Observatory

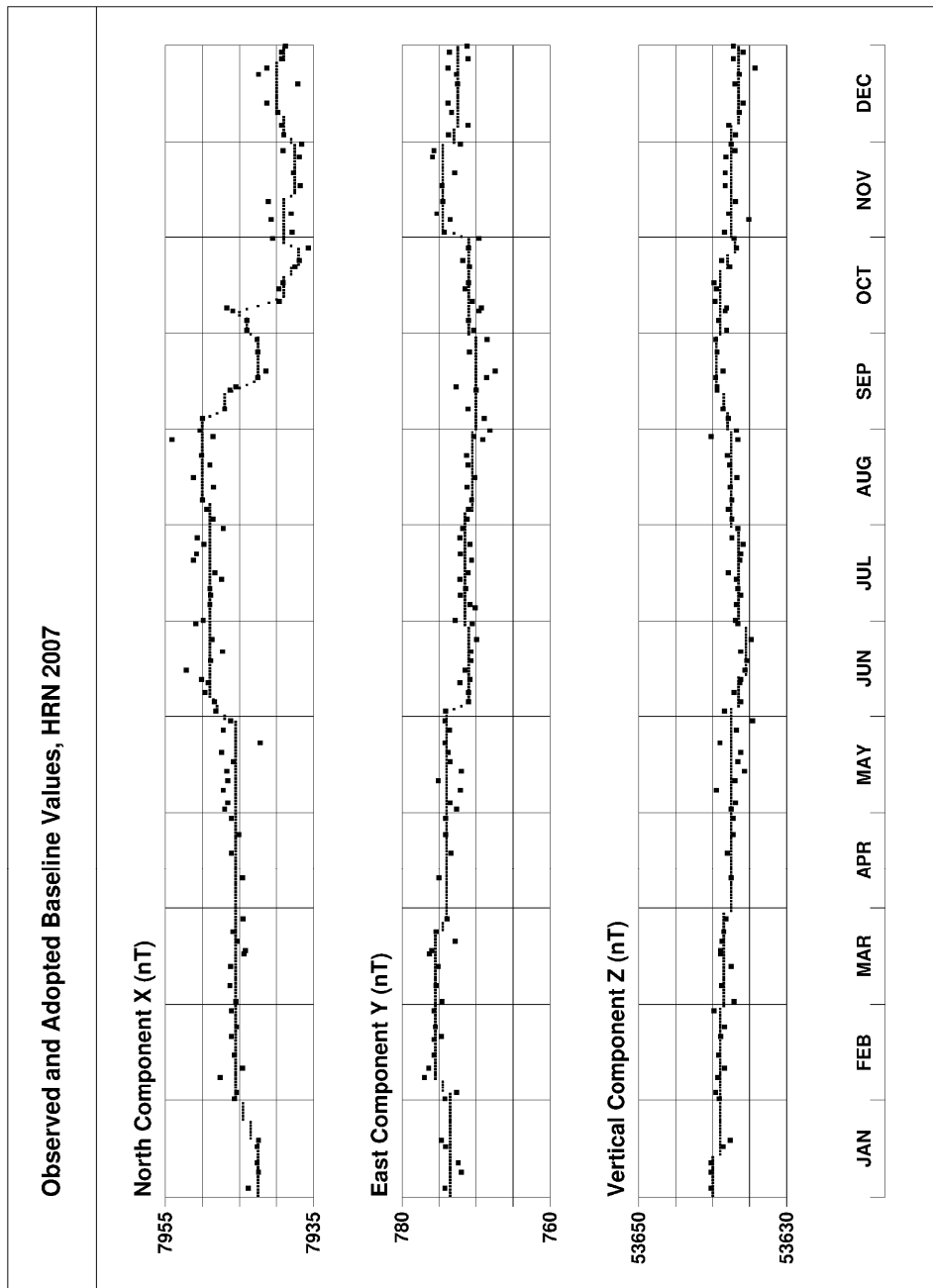

Fig. 25. Base values, Hornsund 2007.

Annual mean values of magnetic elements in Hornsund Observatory

| Year | D [° ´] | H [nT] | Z [nT] | X [nT] | Y [nT] | I [° ´] | F [nT] |
|------|--------------|-------------|-------------|-------------|-------------|--------------|-------------|
| 1979 | -0 32.2 | 8384 | 53447 | 8384 | -79 | 81 05.1 | 54101 |
| 1980 | -0 14.2 | 8370 | 53447 | 8370 | -35 | 81 06.0 | 54098 |
| 1981 | -0 09.3 | 8351 | 53449 | 8351 | -23 | 81 07.2 | 54097 |
| 1982 | -0 09.4 | 8319 | 53481 | 8319 | -23 | 81 09.5 | 54124 |
| 1983 | -0 02.0 | 8295 | 53457 | 8295 | -5 | 81 10.8 | 54097 |
| 1984 | 0 07.7 | 8266 | 53439 | 8266 | 19 | 81 12.4 | 54075 |
| 1985 | 0 14.3 | 8238 | 53405 | 8238 | 34 | 81 13.9 | 54037 |
| 1986 | 0 20.4 | 8213 | 53392 | 8213 | 49 | 81 15.3 | 54020 |
| 1987 | 0 25.6 | 8193 | 53360 | 8193 | 61 | 81 16.3 | 53985 |
| 1988 | 0 34.7 | 8168 | 53368 | 8168 | 82 | 81 17.9 | 53989 |
| 1989 | 0 40.8 | 8148 | 53369 | 8147 | 97 | 81 19.2 | 53987 |
| 1990 | 0 47.2 | 8122 | 53360 | 8121 | 112 | 81 20.7 | 53975 |
| 1991 | 0 53.0 | 8107 | 53355 | 8106 | 125 | 81 21.6 | 53967 |
| 1992 | 1 01.4 | 8088 | 53352 | 8087 | 144 | 81 22.8 | 53962 |
| 1993 | 1 12.9 | 8065 | 53356 | 8063 | 171 | 81 24.3 | 53962 |
| 1994 | 1 25.9 | 8044 | 53374 | 8041 | 201 | 81 25.8 | 53977 |
| 1995 | 1 38.4 | 8038 | 53374 | 8035 | 230 | 81 26.1 | 53976 |
| 1996 | 1 51.4 | 8023 | 53385 | 8019 | 260 | 81 27.2 | 53985 |
| 1997 | 2 07.2 | 8004 | 53406 | 7999 | 296 | 81 28.6 | 54003 |
| 1998 | 2 24.0 | 8001 | 53440 | 7994 | 335 | 81 29.1 | 54036 |
| 1999 | 2 39.1 | 7998 | 53471 | 7989 | 370 | 81 29.6 | 54066 |
| 2000 | 2 55.5 | 7996 | 53504 | 7986 | 408 | 81 30.0 | 54098 |
| 2001 | 3 12.4 | 7992 | 53542 | 7979 | 447 | 81 30.6 | 54135 |
| 2002 | 3 29.7 | 7989 | 53585 | 7974 | 487 | 81 31.2 | 54177 |
| 2003 | 3 49.8 | 7965 | 53646 | 7947 | 532 | 81 33.3 | 54234 |
| 2004 | 4 04.2 | 7961 | 53675 | 7941 | 565 | 81 33.8 | 54262 |
| 2005 | 4 20.5 | 7953 | 53707 | 7930 | 602 | 81 34.6 | 54293 |
| 2006 | 4 36.2 | 7958 | 53727 | 7932 | 639 | 81 34.5 | 54314 |
| 2007 | 4 51.3 | 7950 | 53757 | 7922 | 673 | 81 35.2 | 54342 |

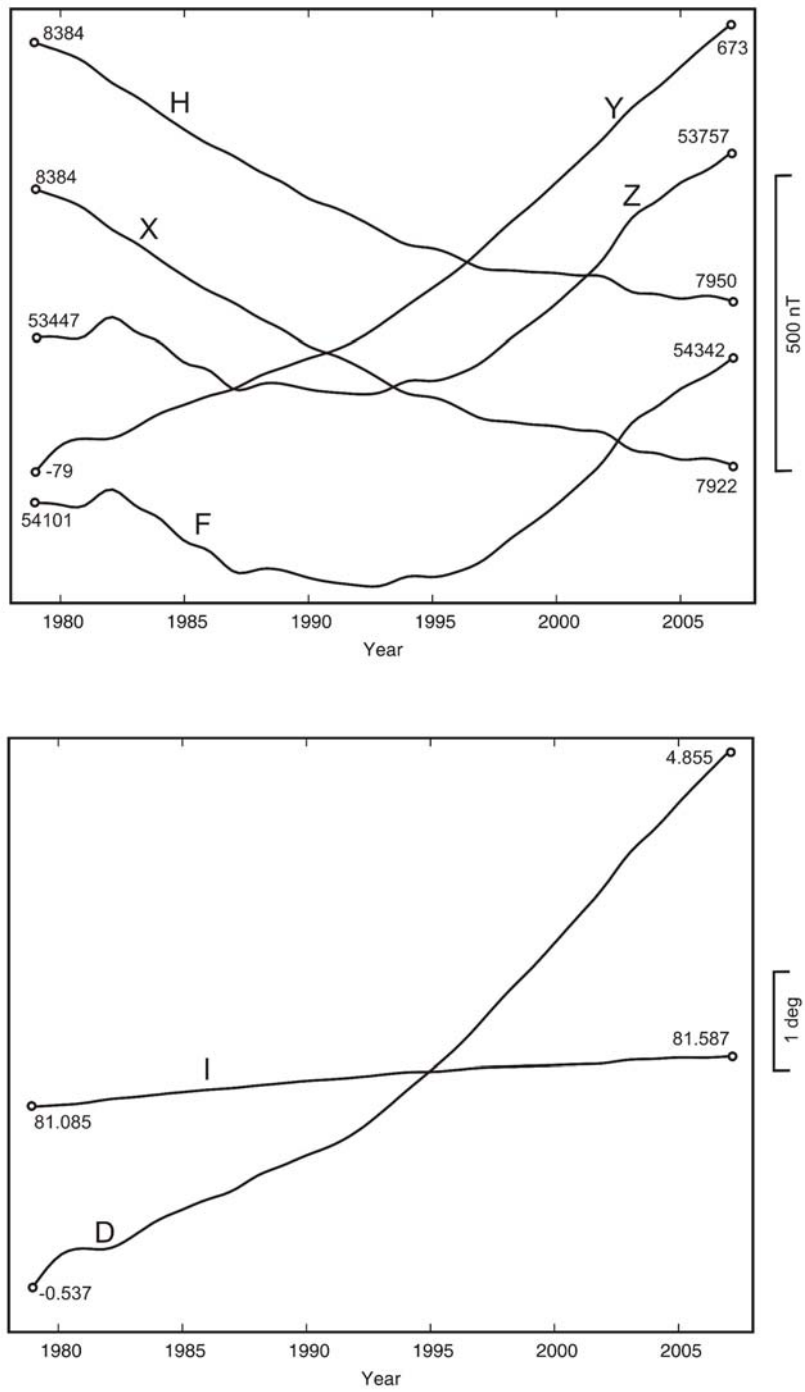

Fig. 26. Secular changes of H, X, Y, Z, F, D and I at Hornsund.

MONTHLY AND YEARLY MEAN VALUES OF MAGNETIC ELEMENTS

| HORNSUND | 2007 | | | | | | | | | | | | |
|----------------|---------------------------------------|-----|-----|-----|-----|-----|-----|-----|-----|-----|-----|-----|------|
| | JAN | FEB | MAR | APR | MAY | JUN | JUL | AUG | SEP | OCT | NOV | DEC | MEAN |
| | NORTH COMPONENT: 7500 + ... in nT | | | | | | | | | | | | |
| All days | 407 | 420 | 424 | 424 | 437 | 442 | 437 | 431 | 420 | 411 | 405 | 408 | 422 |
| Quiet days | 427 | 430 | 432 | 433 | 435 | 439 | 438 | 433 | 432 | 422 | 421 | 421 | 430 |
| Disturbed days | 369 | 403 | 399 | 384 | 425 | 449 | 433 | 416 | 405 | 385 | 371 | 378 | 401 |
| | EAST COMPONENT: 500 + ... in nT | | | | | | | | | | | | |
| All days | 161 | 160 | 164 | 167 | 164 | 167 | 173 | 175 | 181 | 183 | 190 | 191 | 173 |
| Quiet days | 156 | 159 | 158 | 163 | 167 | 165 | 173 | 174 | 178 | 182 | 186 | 188 | 171 |
| Disturbed days | 171 | 162 | 180 | 177 | 167 | 163 | 173 | 176 | 188 | 182 | 199 | 196 | 178 |
| | VERTICAL COMPONENT: 53500 + ... in nT | | | | | | | | | | | | |
| All days | 250 | 251 | 251 | 253 | 252 | 248 | 250 | 254 | 271 | 268 | 269 | 269 | 257 |
| Quiet days | 244 | 243 | 244 | 245 | 250 | 251 | 247 | 250 | 260 | 261 | 262 | 263 | 252 |
| Disturbed days | 274 | 270 | 267 | 273 | 257 | 248 | 235 | 270 | 293 | 279 | 287 | 282 | 270 |

Three-hour-range K indices
Hornsund, January - March, 2007
The limit of K=9 is 2500 nT

| Day | January | | | February | | | March | | |
|-----|---------|------|----|----------|------|----|-------|------|----|
| | K | SK | | K | SK | | K | SK | |
| 1 | 3113 | 4222 | 18 | -343 | 1034 | -- | 4443 | 3210 | 21 |
| 2 | 5333 | 5565 | 35 | 2232 | 2221 | 16 | 0222 | 1133 | 14 |
| 3 | 3343 | 4354 | 29 | 1122 | 2000 | 8 | 0121 | 1101 | 7 |
| 4 | 3443 | 4645 | 33 | 0121 | 0000 | 4 | 0112 | 2122 | 11 |
| 5 | 2343 | 3354 | 27 | 1112 | 2223 | 14 | 4232 | 2252 | 22 |
| 6 | 2221 | 1534 | 20 | 1432 | 1102 | 14 | 2544 | 4133 | 26 |
| 7 | 1110 | 1023 | 9 | 4333 | 3164 | 27 | 4333 | 4664 | 33 |
| 8 | 1112 | 0232 | 12 | 3433 | 2313 | 22 | 3331 | 2130 | 16 |
| 9 | 0210 | 2220 | 9 | 3333 | 1133 | 20 | 0111 | 1112 | 8 |
| 10 | 0332 | 2311 | 15 | 2221 | 1322 | 15 | 1222 | 2144 | 18 |
| 11 | 2232 | 2233 | 19 | 0000 | 0114 | 6 | 1224 | 3222 | 18 |
| 12 | 5211 | 0101 | 11 | 1113 | 3213 | 15 | 1133 | 3255 | 23 |
| 13 | 2000 | 0000 | 2 | 2233 | 1456 | 26 | 6343 | 4452 | 31 |
| 14 | 0010 | 1013 | 6 | 4253 | 3252 | 26 | 3334 | 4513 | 26 |
| 15 | 3333 | 5332 | 25 | 2343 | 3253 | 25 | 2333 | 3224 | 22 |
| 16 | 1432 | 3234 | 22 | 2333 | 3354 | 26 | 4422 | 3105 | 21 |
| 17 | 4343 | 3275 | 31 | 3423 | 3424 | 25 | 2433 | 2220 | 18 |
| 18 | 2433 | 3435 | 27 | 1223 | 2233 | 18 | 0133 | 2112 | 13 |
| 19 | 3432 | 3263 | 26 | 0122 | 2100 | 8 | 1222 | 2122 | 14 |
| 20 | 2343 | 2155 | 25 | 0101 | 1000 | 3 | 0100 | 1031 | 6 |
| 21 | 1343 | 2150 | 19 | 0110 | 1001 | 4 | 0112 | 1000 | 5 |
| 22 | 1022 | 2141 | 13 | 0100 | 0014 | 6 | 1111 | 1111 | 8 |
| 23 | 2433 | 0221 | 17 | 1210 | 1121 | 9 | 0122 | 2212 | 12 |
| 24 | 1010 | 0111 | 5 | 1110 | 0000 | 3 | 4423 | 3111 | 19 |
| 25 | 0112 | 0004 | 8 | 1101 | 1131 | 9 | 2224 | 3212 | 18 |
| 26 | 1211 | 1002 | 8 | 1321 | 0020 | 9 | 1223 | 2512 | 18 |
| 27 | 2111 | 1012 | 9 | 0122 | 2262 | 17 | 2323 | 2252 | 21 |
| 28 | 3211 | 0011 | 9 | 5344 | 3635 | 33 | 2342 | 2141 | 19 |
| 29 | 3233 | 3365 | 28 | | | | 1221 | 1000 | 7 |
| 30 | 3443 | 3256 | 30 | | | | 1232 | 1000 | 9 |
| 31 | 3343 | 3765 | 34 | | | | 1331 | 2001 | 11 |

Three-hour-range K indices
Hornsund, April - June, 2007
The limit of K=9 is 2500

| Day | April | | | May | | | June | | |
|-----|-------|------|----|------|------|----|------|------|----|
| | K | SK | | K | SK | | K | SK | |
| 1 | 4433 | 3355 | 30 | 2433 | 2332 | 22 | 2223 | 1122 | 15 |
| 2 | 3534 | 3255 | 30 | 2311 | 1100 | 9 | 223- | 1222 | -- |
| 3 | 3442 | 2422 | 23 | 1111 | 2232 | 13 | 3322 | 2333 | 21 |
| 4 | 2333 | 3142 | 21 | 1101 | 2110 | 7 | 2323 | 3341 | 21 |
| 5 | 2232 | 1231 | 16 | 0111 | 1001 | 5 | 1111 | 2114 | 12 |
| 6 | 1112 | 2111 | 10 | 1100 | 0002 | 4 | 1301 | 2111 | 10 |
| 7 | 1101 | 2100 | 6 | 1132 | 4532 | 21 | 1211 | 1121 | 10 |
| 8 | 0011 | 2100 | 5 | 2334 | 3242 | 23 | 3321 | 2224 | 19 |
| 9 | 2433 | 2002 | 16 | 1332 | 3221 | 17 | 2334 | 3122 | 20 |
| 10 | 1212 | 2223 | 15 | 1011 | 2252 | 14 | 3423 | 2132 | 20 |
| 11 | 2221 | 1000 | 8 | 1112 | 2121 | 11 | 2121 | 0121 | 10 |
| 12 | 2323 | 4311 | 19 | 1122 | 1101 | 9 | 1211 | 2182 | 18 |
| 13 | 0110 | 0000 | 2 | 1211 | 1200 | 8 | 1122 | 1233 | 15 |
| 14 | 0211 | 2104 | 11 | 0112 | 0220 | 8 | 4344 | 4533 | 30 |
| 15 | 4323 | 1210 | 16 | 0123 | 2133 | 15 | 2333 | 2212 | 18 |
| 16 | 1011 | 1100 | 5 | 1212 | 2004 | 12 | 2423 | 3221 | 19 |
| 17 | 0222 | 2222 | 14 | 1322 | 2222 | 16 | 2333 | 3221 | 19 |
| 18 | 4332 | 1135 | 22 | 2244 | 4332 | 24 | 1223 | 3231 | 17 |
| 19 | 2222 | 2101 | 12 | 2443 | 3442 | 26 | 2232 | 2211 | 15 |
| 20 | 1211 | 1002 | 8 | 3233 | 2253 | 23 | 2221 | 2222 | 15 |
| 21 | 1210 | 0001 | 5 | 2201 | 1112 | 10 | 1324 | 4234 | 23 |
| 22 | 2322 | 2222 | 17 | 1223 | 4254 | 23 | 4343 | 3224 | 25 |
| 23 | 4642 | 2200 | 20 | 5445 | 3355 | 34 | 3432 | 2133 | 21 |
| 24 | 1212 | 2112 | 12 | 3444 | 4536 | 33 | 3333 | 3343 | 25 |
| 25 | 2212 | 4320 | 16 | 2344 | 3532 | 26 | 2221 | 2132 | 15 |
| 26 | 2322 | 2224 | 19 | 3434 | 3442 | 27 | 2212 | 3132 | 16 |
| 27 | 2322 | 3235 | 22 | 2343 | 3553 | 28 | 2322 | 2322 | 18 |
| 28 | 4344 | 6454 | 34 | 3323 | 3032 | 19 | 2212 | 2211 | 13 |
| 29 | 3454 | 4354 | 32 | 1212 | 2221 | 13 | 1222 | 3254 | 21 |
| 30 | 4454 | 3431 | 28 | 2312 | 2120 | 13 | 2221 | 1112 | 12 |
| 31 | | | | 2231 | 1133 | 16 | | | |

Three-hour-range K indices
Hornsund, July - September, 2007
The limit of K=9 is 2500

| Day | July | | | August | | | September | | |
|-----|------|------|----|--------|------|----|-----------|------|----|
| | K | SK | | K | SK | | K | SK | |
| 1 | 1333 | 2212 | 17 | 5444 | 3353 | 31 | 2233 | 2263 | 23 |
| 2 | 1332 | 2101 | 13 | 2343 | 3331 | 22 | 3435 | 4473 | 33 |
| 3 | 1222 | 3323 | 18 | 1322 | 3212 | 16 | 2343 | 3425 | 26 |
| 4 | 3344 | 3542 | 28 | 1212 | 2103 | 12 | 2343 | 2131 | 19 |
| 5 | 2332 | 2144 | 21 | 0021 | 0112 | 7 | 2334 | 3242 | 23 |
| 6 | 3322 | 2333 | 21 | 1113 | 2335 | 19 | 2323 | 3245 | 24 |
| 7 | 2422 | 1144 | 20 | 3543 | 3554 | 32 | 2333 | 2533 | 24 |
| 8 | 3322 | 2121 | 16 | 1333 | 2211 | 16 | 2342 | 2352 | 23 |
| 9 | 1112 | 2110 | 9 | 2231 | 1213 | 15 | 0232 | 2101 | 11 |
| 10 | 0131 | 1013 | 10 | 1223 | 4564 | 27 | 1112 | 1110 | 8 |
| 11 | 3455 | 3221 | 25 | 3333 | 2542 | 25 | 0111 | 1232 | 11 |
| 12 | 2242 | 2222 | 18 | 3333 | 2131 | 19 | 0221 | 1001 | 7 |
| 13 | 1221 | 1212 | 12 | 1111 | 1121 | 9 | 0122 | 0002 | 7 |
| 14 | 2233 | 3463 | 26 | 2102 | 1232 | 13 | 2012 | 2112 | 11 |
| 15 | 5333 | 2241 | 23 | 2332 | 2211 | 16 | 2111 | 1123 | 12 |
| 16 | 2222 | 2221 | 15 | 2223 | 2212 | 16 | 2211 | 0010 | 7 |
| 17 | 2222 | 1121 | 13 | 2122 | 2124 | 16 | 0010 | 1003 | 5 |
| 18 | 2222 | 0110 | 10 | 3111 | 1001 | 8 | 2201 | 2000 | 7 |
| 19 | 0011 | 0010 | 3 | 1002 | 3110 | 8 | 0132 | 2000 | 8 |
| 20 | 1234 | 5324 | 24 | 2111 | 2001 | 8 | 0211 | 2243 | 15 |
| 21 | 3533 | 3232 | 24 | 2212 | 2210 | 12 | 2332 | 2215 | 20 |
| 22 | 2232 | 2211 | 15 | 0111 | 3310 | 10 | 3432 | 3254 | 26 |
| 23 | 1222 | 2112 | 13 | 0112 | 1111 | 8 | 3453 | 2215 | 25 |
| 24 | 0013 | 2101 | 8 | 1101 | 0000 | 3 | 3544 | 3543 | 31 |
| 25 | 1210 | 2110 | 8 | 2212 | 3221 | 15 | 2323 | 1154 | 21 |
| 26 | 0001 | 2333 | 12 | 1223 | 3443 | 22 | 1333 | 1033 | 17 |
| 27 | 3332 | 2210 | 16 | 4343 | 3263 | 28 | 0113 | 1454 | 19 |
| 28 | 2111 | 2113 | 12 | 3334 | 3135 | 25 | 3443 | 3264 | 29 |
| 29 | 3532 | 2324 | 24 | 2221 | 2143 | 17 | 3355 | 4365 | 34 |
| 30 | 2333 | 2322 | 20 | 1222 | 1133 | 15 | 3444 | 3263 | 29 |
| 31 | 1233 | 3222 | 18 | 0212 | 1214 | 13 | | | |

Three-hour-range K indices
Hornsund, October - December, 2007
The limit of K=9 is 2500

| Day | October | | | November | | | December | | |
|-----|---------|------|----|----------|------|----|----------|------|----|
| | K | SK | | K | SK | | K | SK | |
| 1 | 2424 | 3323 | 23 | 2222 | 2131 | 15 | 3211 | 1000 | 8 |
| 2 | 2222 | 2234 | 19 | 0221 | 1011 | 8 | 1113 | 0012 | 9 |
| 3 | 4433 | 4246 | 30 | 0212 | 1010 | 7 | 0000 | 0000 | 0 |
| 4 | 2233 | 3461 | 24 | 0021 | 1543 | 16 | 1000 | 1101 | 4 |
| 5 | 1433 | 3231 | 20 | 1232 | 0100 | 9 | 1111 | 0000 | 4 |
| 6 | 1232 | 2112 | 14 | 0000 | 1100 | 2 | 0221 | 2043 | 14 |
| 7 | 1223 | 1121 | 13 | 1111 | 0000 | 4 | 1211 | 0020 | 7 |
| 8 | 0110 | 1003 | 6 | 0111 | 0000 | 3 | 0000 | 0002 | 2 |
| 9 | 1201 | 0010 | 5 | 1111 | 1102 | 8 | 0200 | 0142 | 9 |
| 10 | 0010 | 0010 | 2 | 2222 | 2211 | 14 | 0122 | 2232 | 14 |
| 11 | 0000 | 0022 | 4 | 1213 | 1011 | 10 | 2343 | 3454 | 28 |
| 12 | 0122 | 1013 | 10 | 1001 | 0031 | 6 | 2343 | 2115 | 21 |
| 13 | 0011 | 1002 | 5 | 4332 | 2132 | 20 | 4323 | 2251 | 22 |
| 14 | 3121 | 2100 | 10 | 2343 | 3224 | 23 | 2332 | 1143 | 19 |
| 15 | 0111 | 1000 | 4 | 2322 | 3353 | 23 | 2113 | 2213 | 15 |
| 16 | 0010 | 1220 | 6 | 2343 | 2255 | 26 | 0231 | 0105 | 12 |
| 17 | 2100 | 0000 | 3 | 5333 | 1330 | 21 | 2443 | 4445 | 30 |
| 18 | 0123 | 2122 | 13 | 0311 | 0200 | 7 | 5444 | 3556 | 36 |
| 19 | 2443 | 4354 | 29 | 1010 | 1012 | 6 | 2443 | 3256 | 29 |
| 20 | 4443 | 1231 | 22 | 2234 | 4443 | 26 | 2343 | 3355 | 28 |
| 21 | 1232 | 3142 | 18 | 4433 | 3244 | 27 | 3444 | 2364 | 30 |
| 22 | 1211 | 1243 | 15 | 1333 | 2442 | 22 | 1223 | 3544 | 24 |
| 23 | 3223 | 3041 | 18 | 5343 | 3244 | 28 | 4343 | 3424 | 27 |
| 24 | 1111 | 1101 | 7 | 3333 | 2463 | 27 | 1222 | 1124 | 15 |
| 25 | 1124 | 4553 | 25 | 3444 | 3645 | 33 | 0111 | 1101 | 6 |
| 26 | 2343 | 2663 | 29 | 4333 | 2253 | 25 | 0111 | 1101 | 6 |
| 27 | 2333 | 3533 | 25 | 1322 | 2244 | 20 | 1221 | 1013 | 11 |
| 28 | 2323 | 3533 | 24 | 1122 | 2444 | 20 | 2221 | 1033 | 14 |
| 29 | 2222 | 2266 | 24 | 1112 | 2423 | 16 | 0022 | 1003 | 8 |
| 30 | 2332 | 1551 | 22 | 1221 | 1123 | 13 | 2111 | 1110 | 8 |
| 31 | 2233 | 3252 | 22 | | | | 1111 | 1122 | 10 |

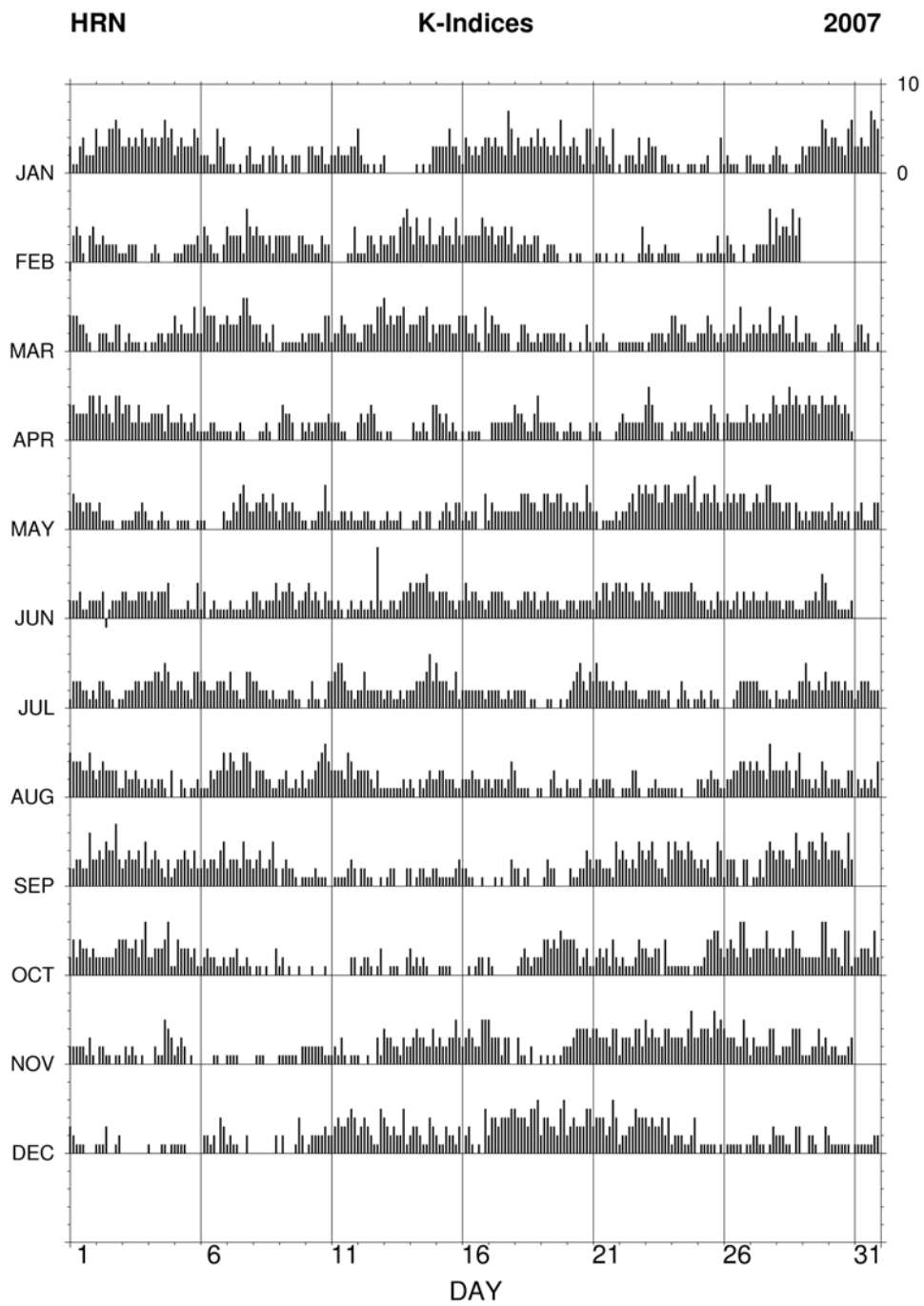

Fig. 27. K-indices in graphical form, Hornsund 2007.

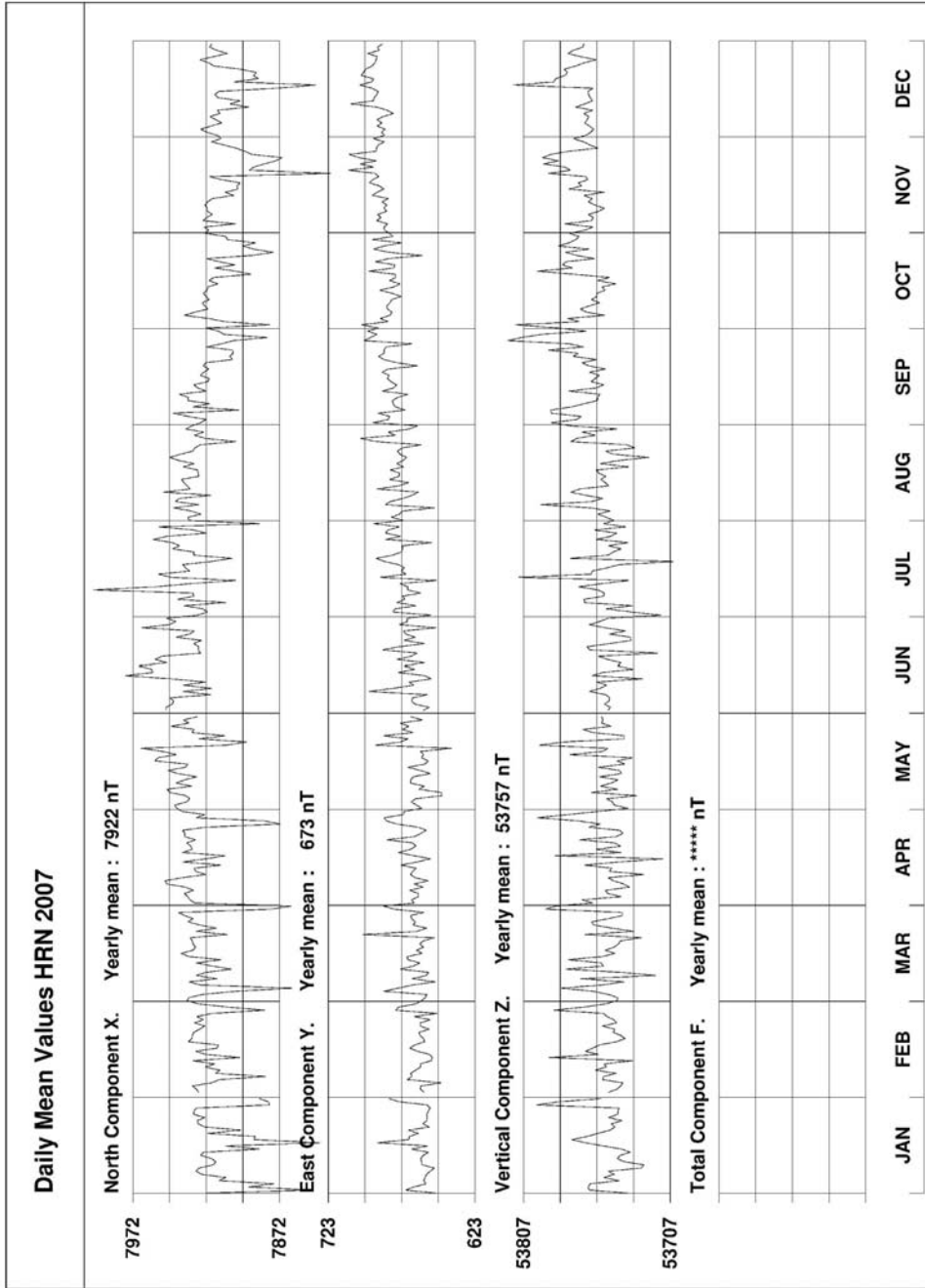

Fig. 28. Daily mean data plot for Hornsund 2007.

HRN - Hourly Mean Values

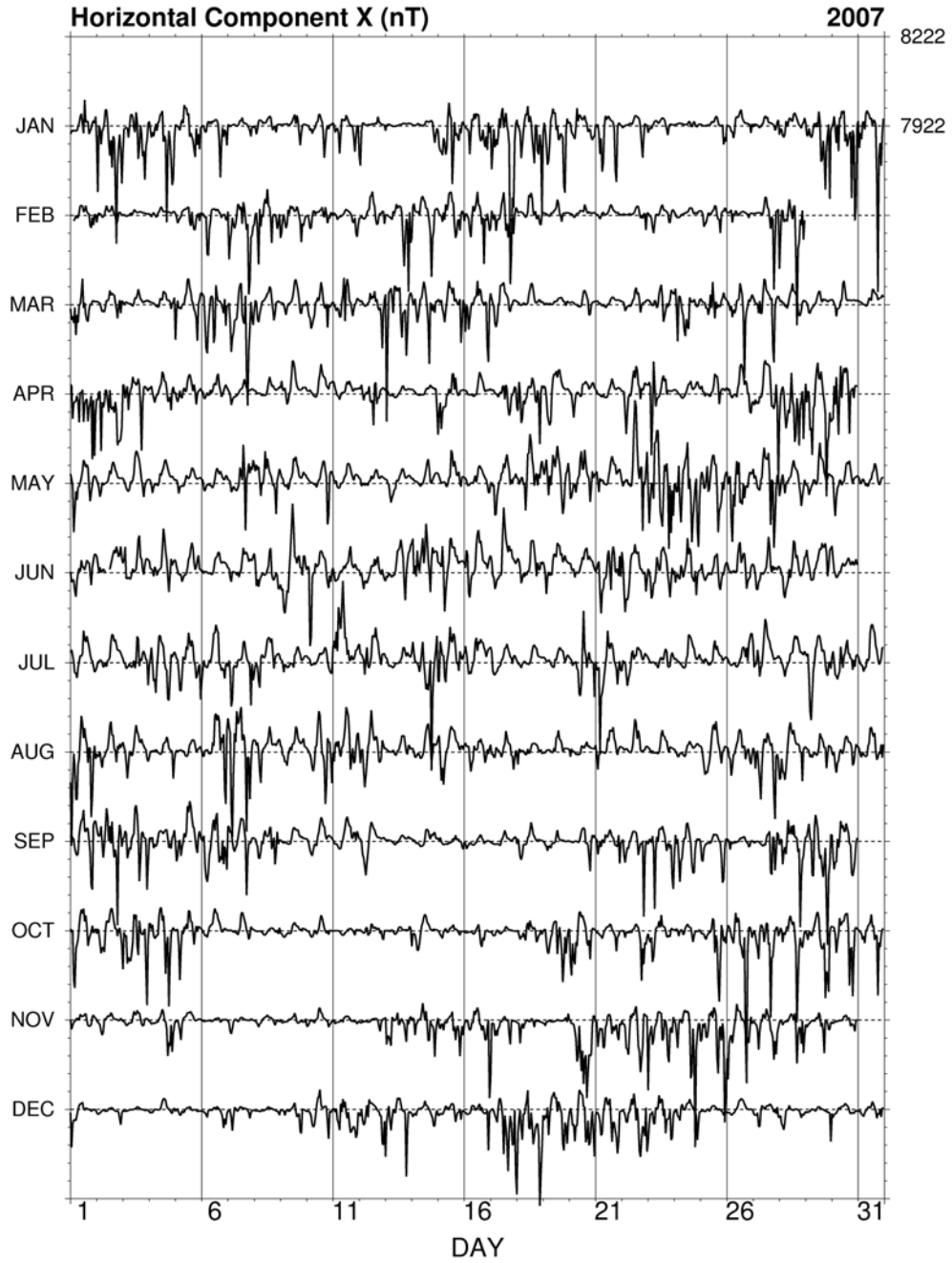

Fig. 29. Hourly mean data plot of X component for Hornsund.

HRN - Hourly Mean Values



Fig. 30. Hourly mean data plot of Y component for Hornsund.

HRN - Hourly Mean Values

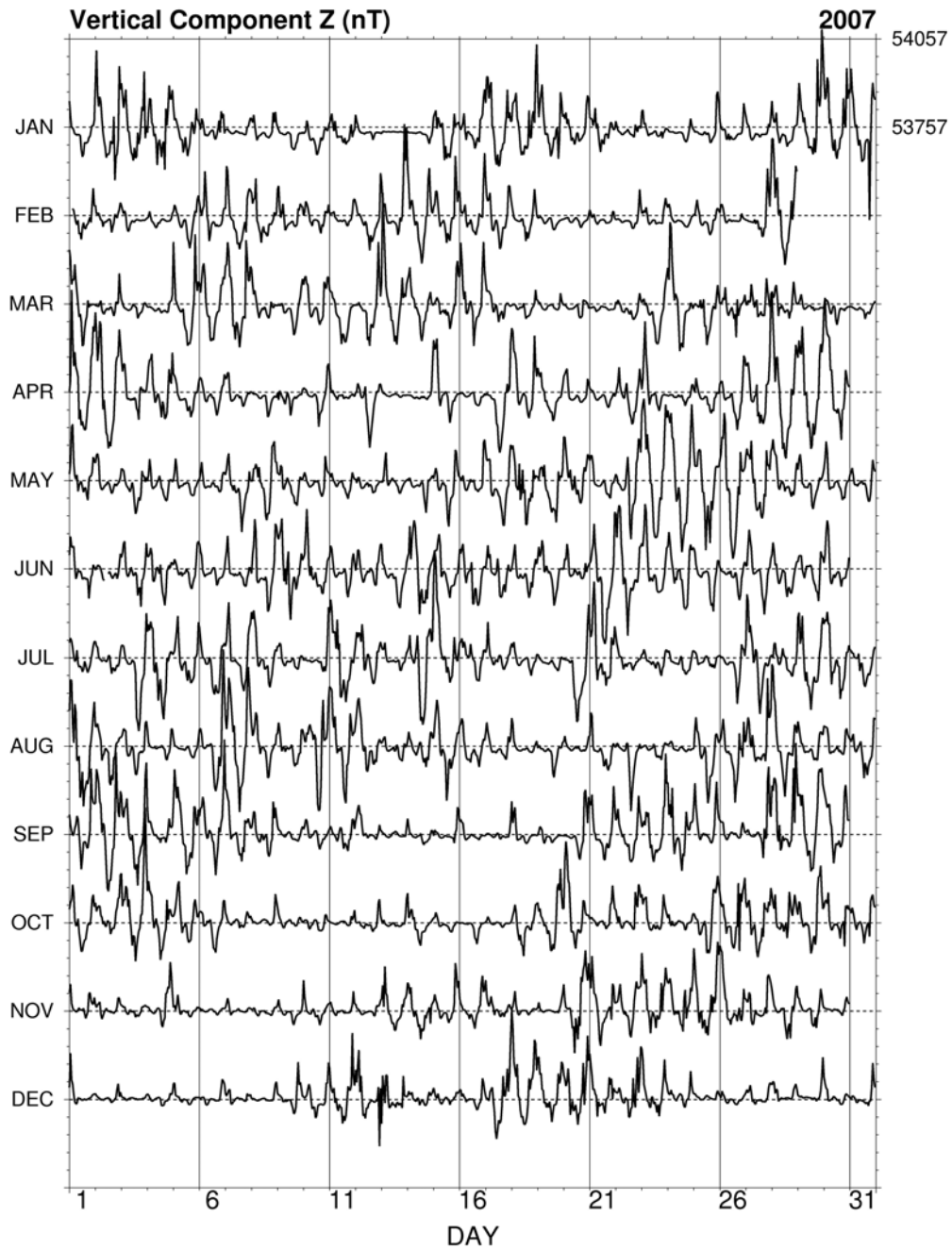

Fig. 31. Hourly mean data plot of Z component for Hornsund.

List of Yearbooks from Polish Geomagnetic Observatories

Below is the list of yearbooks with the results from the Polish geomagnetic observatories. Since the year 2006, one joint yearbook has been published in place of individual yearbooks from each observatory. The present edition is an activity report, and refers the reader to the internet where one-minute data are available. Most of the issues listed below are still available from the Institute of Geophysics.

I. Results of Geomagnetic Observations Belsk, Hel, Hornsund (since 2006)

Published in

Publications of the Institute of Geophysics, Pol. Acad. Sc.:

2006 – no C-100 (402)

II. Results of Geomagnetic Observations, Belsk Geophysical Observatory (1966-2005)

Published in

Materiały i Prace Zakładu Geofizyki PAN:

1966 – no 20; 1967 – no 27; 1968 – no 42; 1969 – no 46;

1970 – no 50; 1971 – no 57; 1972 – no 70; 1973 – no 76;

1974 – no 88

Publications of the Institute of Geophysics, Pol. Acad. Sc.:

1975 – no C-2 (107); 1976 – no C-4 (114); 1977 – no C-5 (125);

1978 – no C-8 (133); 1979 – no C-9 (139); 1980 – no C-10- (144);

1981 – no C-13 (159); 1982 – no C-17 (166); 1983 – no C-20 (180);

1984 – no C-23 (187); 1985 – no C-26 (196); 1986 – no C-29 (205);

1987 – no C-34 (218); 1988 – no C-37 (227); 1989 – no C-38 (228);

1990 – no C-40 (240); 1991 – no C-45 (250); 1992 – no C-49 (259);
 1993 – no C-51 (267); 1994 – no C-55 (277); 1995 – no C-58 (287);
 1996 – no C-61 (296); 1997 – no C-68 (305); 1998 – no C-70 (312);
 1999 – no C-74 (318); 2000 – no C-79 (328); 2001 – no C-82 (343);
 2002 – no C-85 (356); 2003 – no C-89 (368); 2004 – no C-92 (379);
 2005 – no C-96 (392)

III. Results of Geomagnetic Observations, Hel Geophysical Observatory (1958-2005)

Published in

Publications of the Institute of Geophysics, Pol. Acad. Sc.:

1958-1965 – no C-41 (241); 1966-1970 – no C-6 (127);
 1971-1975 – no C-7 (128); 1976-1979 – no C-11 (154);
 1980-1981 – no C-16 (165) 1982 – no C-18 (170);
 1983 – no C-19 (179); 1984 – no C-24 (128); 1985 – no C-25 (195);
 1986 – no C-30 (206); 1987 – no C-33 (217); 1988 – no C-36 (226);
 1989 – no C-39 (239); 1990 – no C-42 (242); 1991 – no C-46 (251);
 1992 – no C-50 (260); 1993 – no C-52 (268); 1994 – no C-56 (278);
 1995 – no C-59 (288); 1996 – no C-62 (297); 1997 – no C-67 (304);
 1998 – no C-71 (313); 1999 – no C-76 (320); 2000 – no C-81 (330);
 2001 – no C-84 (345); 2002 – no C-87 (358); 2001 – no C-84 (345);
 2003 – no C-91 (370); 2004 – no C-94 (381); 2005 – no C-98 (394)

IV. Results of Geomagnetic Observations, Polish Polar Station Hornsund, Spitsbergen (1978-2005)

Published in

Publications of the Institute of Geophysics, Pol. Acad. Sc.:

1978-1979 – no C-14 (163); 1980-1981 – no C-27 (199);
 1982-1983 – no C-31 (210); 1984-1985 – no C-43 (243);

| | | |
|----------------------------|----------------------------|-----------------------|
| 1986-1987 – no C-47 (254); | 1988-1989 – no C-48 (256); | |
| 1990-1991 – no C-53 (272); | 1992-1993 – no C-57 (286); | |
| 1994-1995 – no C-64 (301); | 1996 – no C-66 (303); | |
| 1997 – no C-69 (311); | 1998 – no C-72 (315); | 1999 – no C-75 (319); |
| 2000 – no C-80 (329); | 2001 – no C-83 (344); | 2002 – no C-86 (357); |
| 2003 – no C-90 (369); | 2004 – no C-93 (380); | 2005 – no C-97 (393) |

V. Results of Geomagnetic Observations, Polish Antarctic Station Arctowski (1978-1995)

Published in

Publications of the Institute of Geophysics, Pol. Acad. Sc.:

| | |
|----------------------------|----------------------------|
| 1978-1979 – no C-21 (181); | 1980-1981 – no C-22 (182); |
| 1982-1983 – no C-28 (202); | 1984-1985 – no C-32 (212); |
| 1986-1987 – no C-35 (225); | 1988-1989 – no C-44 (244); |
| 1990-1991 – no C-54 (276); | 1992-1993 – no C-60 (292); |
| 1994-1995 – no C-63 (300) | |

VI. Yearbooks from Świder Observatory (1937-1967)

Annales Magnetiques (Roczniki magnetyczne) for the years 1937-1967 were published in *Travaux de l'Observatoire Geophysique de St. Kalinowski a Swider (Prace Obserwatorium Geofizycznego im. St. Kalinowskiego w Świdrze)*.

CONTENTS

| | |
|---|----|
| Results of Geomagnetic Observations Belsk, Hel, Hornsund 2007 | 3 |
| Tables and plots for Belsk Observatory | 17 |
| Tables and plots for Hel Observatory..... | 33 |
| Tables and plots for Hornsund Observatory..... | 49 |
| List of Yearbooks from Polish Geomagnetic Observatories | 63 |